

December 17, 2008 Subject: **Predelivery Inspection**

No. **2009-2**

All Models Except GTX LTD and RXT iS
Other countries outside North America

MODEL	PACKAGE	MODEL NUMBER	ENGINE (HP)	PREDELIVERY KIT	SERIAL NUMBER
GTX [†]	STD	149B	1503NA (155)	294 000 842	All
	STD	339B	1503BVIC (215)		
	WAKE PRO	269B	1503BVIC (215)		
RXT™	STD	179B / 179D	1503BVIC (215)	294 000 843	
	X RS	319B	1503BVIC HO (255)	294 000 844	
GTI™	STD	239B	1503DT (130)	294 000 847	
	STD R	259B	1503DT (130)	294 000 846	
	SE	249B	1503DT (130)	294 000 845	
	SE	309B	1503NA (155)		
	WAKE	359B	1503NA (155)		
RXP™	STD	219B	1503BVIC (215)	294 000 848	
	X RS	329B	1503BVIC HO (255)	294 000 849	

GTX[†] is a trademark of Castrol Ltd. Used under license

TABLE OF CONTENTS

	Page		Page
IMPORTANT NOTICE	2	Storage Cover Installation	10
UNCRATING	3	Storage Cover Shock Installation	12
Crate Cover	3	Deflector Installation	12
Shipping Bracket	3	FINAL PREPARATION	13
Lifting the Watercraft	3	B.U.D.S. Programming	13
SET-UP	4	Fuel	15
Battery Removal, Preparation and		Engine Oil Level	15
Installation	4	Engine Coolant Level	16
Venturi Installation	5	Steering Alignment	17
Rear View Mirrors Installation	5	O.P.A.S.™ System Alignment	18
Reverse Handle Installation	6	Throttle Cable Adjustment	18
Handlebar Assembly Installation	7	Protective Films Removal	18
Handlegrip Installation	9	Final Inspection	18
Throttle Cable Installation	9	Watercraft Cleaning	18
Steering Harness Installation	10	DELIVERY TO CUSTOMER	19
Steering Rubber Boot Installation	10	Vehicle Delivery	19

Accessories	19	RXP Models	22
SPECIFICATIONS	20	RXT Models	23
GTI Models	20	Wake Models	24
GTX Models	21		

IMPORTANT NOTICE

This bulletin must be used in conjunction with the *PRE-DELIVERY CHECK LIST* enclosed in the shrink pack.

WARNING

To obtain limited warranty coverage, pre-delivery procedures must be performed by an authorized Sea-Doo watercraft dealer/distributor. Apply all necessary torques as indicated.

— The information and components/system descriptions contained in this document are correct at the time of publication. However, BRP maintains a policy of continuous improvement of its products without imposing upon itself any obligation to install them on products previously manufactured.

— Due to late changes, there might be some differences between the manufactured product and the descriptions and/or specifications in this document. BRP reserves the right at any time to discontinue or change specifications, designs, features, models or equipment without incurring obligation.

— The illustrations in this document show the typical construction of the different assemblies and may not reproduce the full detail or exact shape of the parts; however, they represent parts that have the same or similar function.

— The content of this bulletin is designed as a guideline only. All mechanics performing pre-delivery procedures should have attended the current model year service training.

— Further information or inquiries should be directed to your distributor service representative and/or specific *SHOP MANUAL* sections.

— Please complete the *PREDELIVERY CHECK LIST* for each watercraft and retain a purchaser signed copy.

— Make sure the purchaser receives the *OPERATORS GUIDE*, *PREDELIVERY CHECK LIST* signed copy and *SAFETY VIDEO*.

WARNING

Torque wrench tightening specifications must be strictly adhered to. Where specified, install new locking devices (e.g. lock tabs, elastic stop nuts). If the efficiency of a locking device is impaired, it must be renewed.

UNCRATING

Crate Cover

1. Carefully lay crate on its bottom.

NOTICE Allowing crate to drop may cause serious damage to watercraft.

2. Remove all screws retaining crate cover to crate base.

NOTE: Screws that are used are Robertson† #2 type that require the use of an appropriate bit (Scrulox #2 from Snap-on†† Tools or ECAR.1 from Facom††† Tools).

3. Assisted by another person, lift up crate cover.

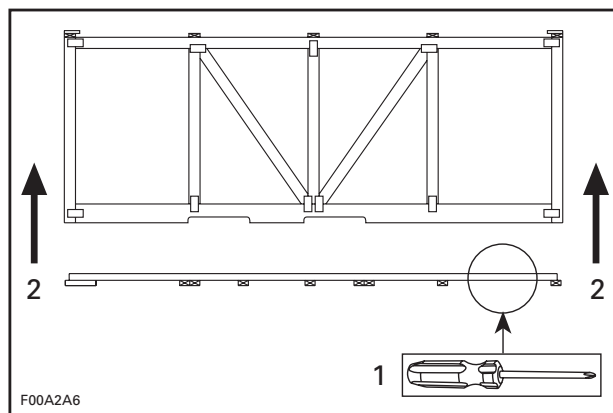

TYPICAL

1. Remove screws
2. Raise cover vertically

NOTE: Do not tip cover toward front or back of watercraft. Raise cover vertically from both ends at the same time.

4. Remove watercraft protective bag.
5. Remove parts from watercraft's storage compartments and from crate.

Engine Foam Protector

1. Remove seat(s).
2. Remove the foam protector supporting engine.

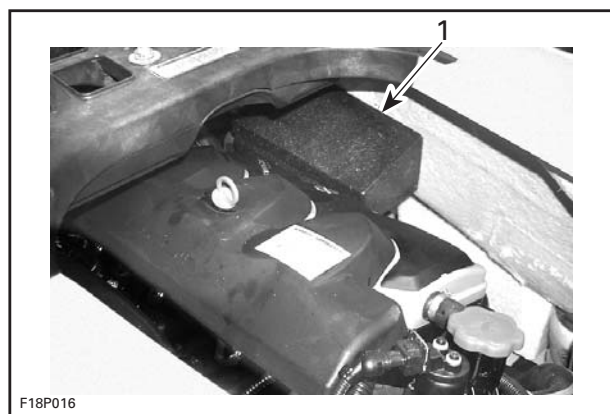

TYPICAL

1. Foam protector

Shipping Bracket

1. Remove shipping bracket from venturi.
2. Discard shipping bracket and hexagonal bolts. Keep the flat washers.

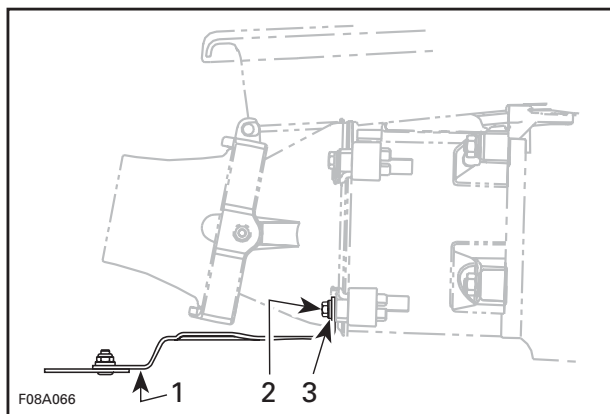

TYPICAL

1. Shipping bracket
2. Hexagonal bolt
3. Flat washer

Lifting the Watercraft

1. Cut strapping at watercraft front eyelet.
2. Release shipping bracket at rear of watercraft from crate base.
3. Lift watercraft using appropriate lift kit and install it on a proper support.

† Robertson is a registered trademark of Robertson Inc.

†† Snap-on is a trademark of Snap-on Inc.

††† FACOM is a brand of International tools Group, subsidiary of FIMALAC.

SET-UP

Battery Removal, Preparation and Installation

Battery Removal

⚠ WARNING

Never charge or boost battery while installed in watercraft.

The battery may be located under the front storage compartment or under the seat, depending on models.

1. Unscrew the battery support.

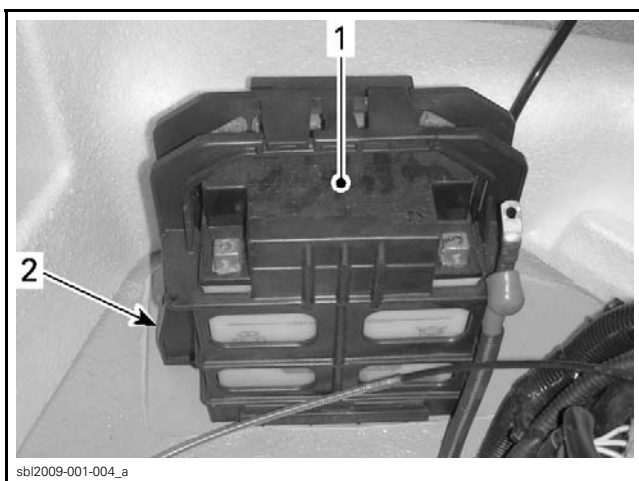

TYPICAL

1. battery support
2. Screws

NOTE: On some models, a locking tie supporting the engine oil vapors return hose to the battery support may required to be removed. **Be sure to install a new one** when battery will be reinstall.

2. Remove battery from watercraft.

Battery Activation

Refer to the latest edition of *SEA-DOO BATTERIES ACTIVATION, CHARGING AND MAINTENANCE BULLETIN* and to instructions notice attached to battery for proper activating, charging and maintenance procedure.

Battery Installation

⚠ WARNING

Always connect battery cables exactly in this specific order. Connect RED positive cable first, then BLACK negative ground cable.

1. Secure RED positive cable to battery positive post with:
 - 1 hexagonal bolt,
 - 1 flat washer and
 - 1 nut, all from predelivery kit (P/N 250 000 282).
2. Apply dielectric grease (P/N 293 550 004) on positive battery post.
3. Cover positive battery post with rubber boot.

NOTE: On RXP models, RED positive cable **must be installed at a 45° angle** while BLACK negative cable is still accepted at a 90° angle.

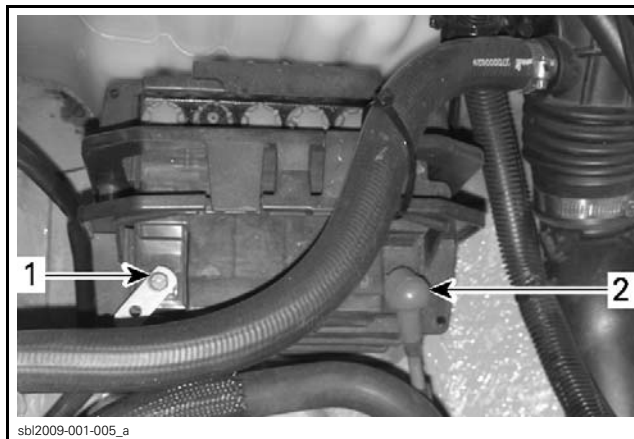

TYPICAL

1. BLACK negative cable
2. RED positive cable

4. Secure BLACK negative cable to negative battery post with:
 - 1 hexagonal bolt,
 - 1 flat washer and
 - 1 nut, all from predelivery kit (P/N 250 000 282).
5. Apply dielectric grease (P/N 293 550 004) on negative battery post.
6. Secure battery with previously removed bracket, flat washers and nuts.
7. Install battery vent tube.

NOTE: GTI rental models comes with a sealed battery. No vent tube installation is needed.

⚠ WARNING
 Ensure vent tube is not kinked or obstructed. Battery vent tube must be properly installed and secured with a locking tie.

Venturi Installation

- Secure lower portion of the venturi with:
 - 2 hexagonal bolts (with scotch grip) from pre-delivery kit (refer to table below).
 - 2 M8 flat washers (previously removed).

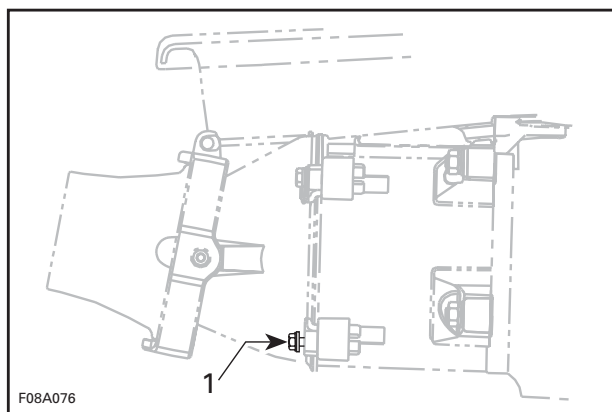

1. Venturi lower portion

MODELS	BOLT
149B / 239B / 249B / 359B / 309B	M8 x 50 with scotch-grip
339B / 269B / 179B / 179D / 319B / 259B / 219B / 329B	M8 x 40 with scotch-grip

- Torque to 21 N•m (15 lbf•ft).

Rear View Mirrors Installation

RXT and RXT-X RS Models WITH the cluster bezel already installed

NOTICE Cluster's locking tabs may break when removing cluster bezel; extreme care must be taken while performing bezel removing procedure.

- Take a small wooden stick (coffee stirrer type) and chamfer its end; refer to photo.

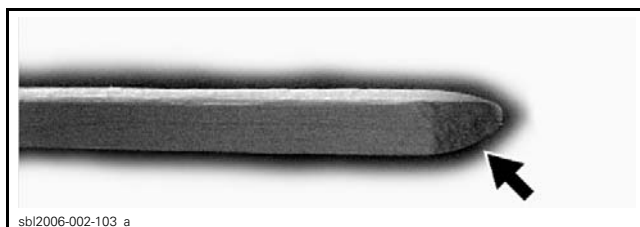

- Slide chamfered end between bezel and cluster, in line with each side locking tab, pushing out smoothly while lifting out bezel.
- Repeat procedure with lower locking tab.
- Gently lift bezel upward, out of its upper locking tabs.

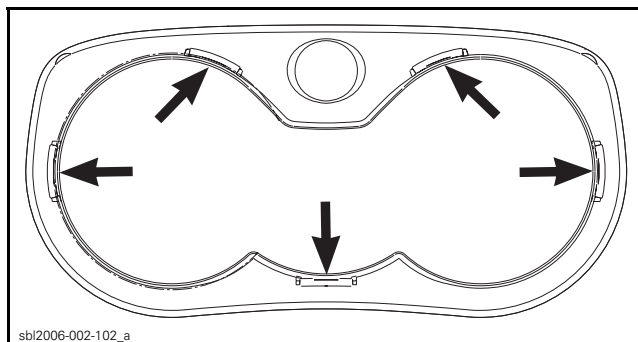
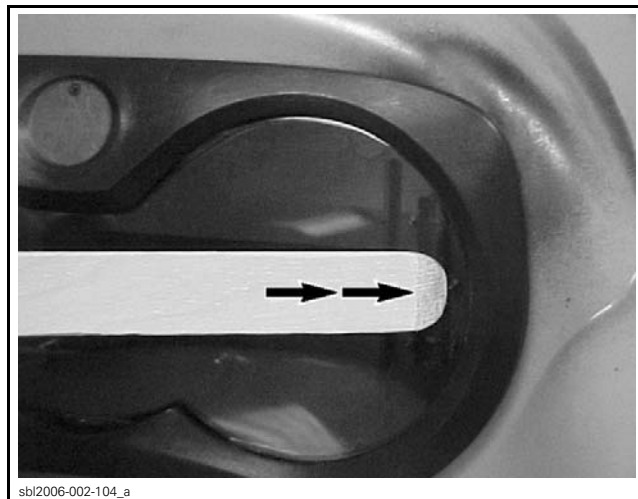

All RXT and RXT-X RS Models

- Remove and keep both screws retaining instrument cluster. Unplug and set cluster aside for now.

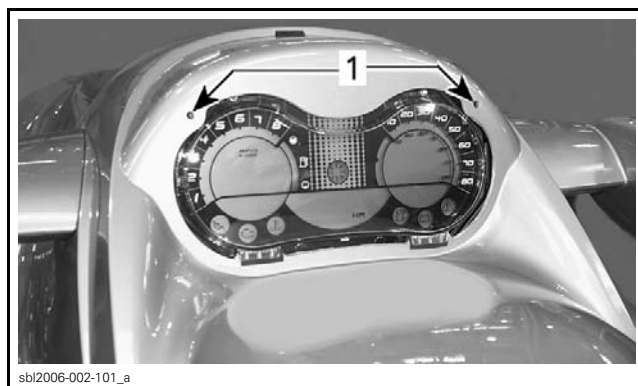

1. Screws

NOTE: At 2 places at bottom of cluster, rubber shims are folded on body for a tight fit; care should be taken not to lose those shims so they are reused when reinstalling cluster.

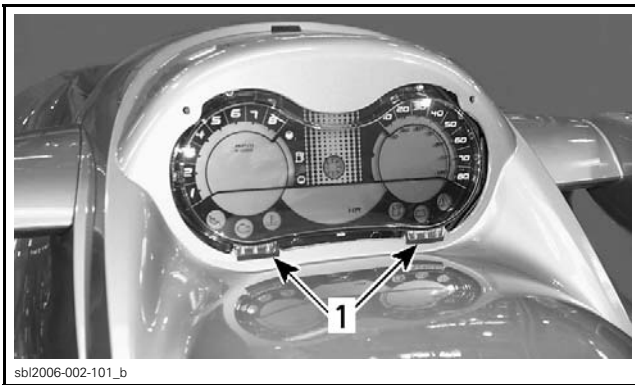

1. Rubber shims

On some models, it is required to cut the locking tie retaining support plate to front storage cover or to mirror.



2. Install rear view mirrors on both sides.

NOTE: Install left and right mirrors so that inscription "OBJECTS IN MIRROR ARE CLOSER THAN THEY APPEAR" is in upright position.

3. Secure each mirror with:

- 2 M8 x 120 hexagonal bolts (P/N 230 062 060) and
- 2 M8 stainless steel flat washers (P/N 234 062 500), all from predelivery kit .

4. Torque to 5 N•m (44 lbf•in).

NOTE: To ensure a correct installation, torque rear bolts (closest to mirror) before front ones.

5. Reconnect instrument cluster and secure back in place using same screws.

6. Torque screws to a **MAXIMUM** of 1.5 N•m (13 lbf•in).

7. Install instrument cluster bezel simply by pushing it in so it snaps back in place.

- 7.1 If the instrument cluster bezel was already installed, reinstall as removed.
- 7.2 If the instrument cluster bezel was not already installed, it will be in mirror bag.

GTI SE Models

1. Pull out temporary plastic fasteners, 2 retaining pod and 2 retaining glove box.
 2. Set glove box aside.
 3. Align mirror support inside pod to install each side mirror.
 4. Secure each mirror with:
 - 2 M8 x 120 socket head bolts and
 - 2 M8 stainless steel flat washers , all from predelivery kit .
 5. Insert rearward screw through mirror support hole and in mirror and tighten manually.
- NOTE:** Install left and right mirror so that the inscription "OBJECTS IN MIRROR ARE CLOSER THAN THEY APPEAR" is in upright position.
6. Insert forward screw and tighten manually.
 7. Without touching mirrors, complete tightening both mirrors in the following sequence:
 - left rear screw then right rear;
 - left front screw then right front.
 8. Torque to 5 N•m (44 lbf•in).
 9. Reinstall pod in place and insert 6 new rivets (P/N 293 150 123) (from predelivery kit) in their respective holes; do not pop yet.
 10. Reinstall box in place and insert 4 new rivets (P/N 293 150 123) (from predelivery kit) in their respective holes; do not pop yet.
 11. Secure mirror support using M10 stainless steel flat washer (P/N 234 002 600) and M10 x 40 socket head screw (P/N 205 004 060) from predelivery kit ; start screwing only to grab threads; do not torque yet.
 12. Pop all rivets, box's and pod's and then, tighten mirror support screw. Torque to 8 N•m (71 lbf•in).

GTI std and GTI std R Models

1. Insert 6 new rivets (from predelivery kit) in their respective holes, in pod; do not pop yet.
2. Insert 4 new rivets (from predelivery kit) in their respective holes, in box; do not pop yet.
3. Now that all rivets are in position, pop them from left to right and front to rear.

Reverse Handle Installation

GTI std, GTI std R, GTI SE Models

1. Install reverse handle (from glove box) using:
 - Guide (P/N 268 000 023)

- Pop rivet (P/N 204 000 081)
- 2 Phillips† M5 x 12 (P/N 250 000 319) screws.

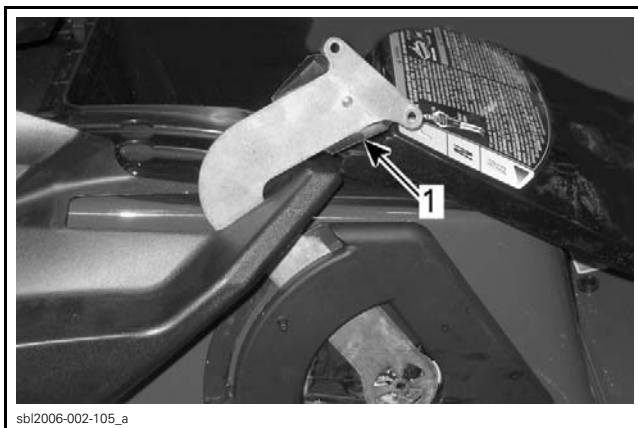

1. Guide (P/N 268 000 023)

Handlebar Assembly Installation

1. Remove both wing nuts from threaded studs on console.
2. Open front storage cover and remove storage tray (if so equipped).

All except X RS Models

3. Install cable support on steering support and secure with:
 - 3 M6 x 20 hexagonal bolts (P/N 207 162 060)
Apply Loctite†† 243 (blue – threadlocker) on bolt threads.
 - 3 M6 flat washers (P/N 234 061 600).

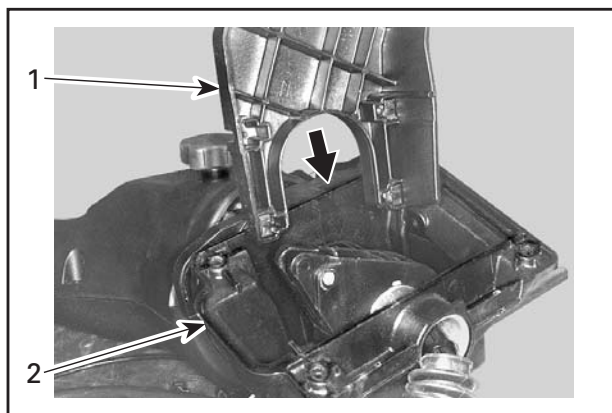

1. Cable support
2. Steering support

Torque to 5 N•m (44 lbf•in).

4. Insert throttle cable and steering harness through console hole and position steering assembly.

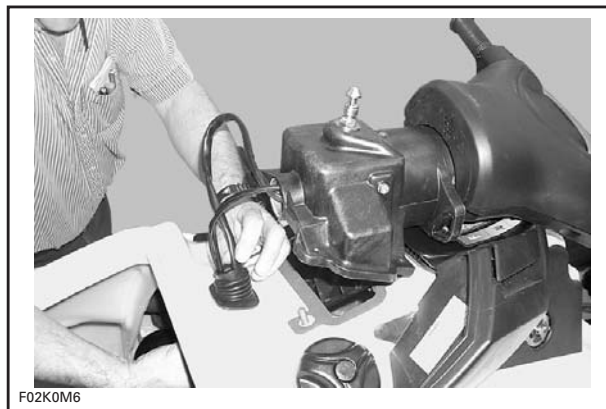

F02K0M6

X RS Models

Handlebar is now strapped to the stern eyelets, on the rear deck.

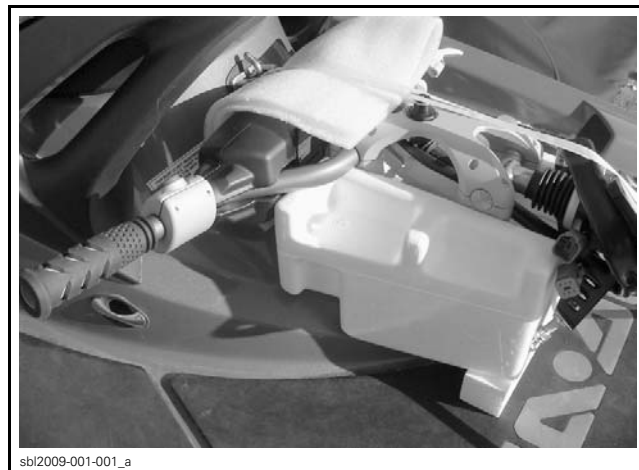

sb12009-001-001_a

PACKAGED HANDLEBAR

5. Unwrap handlebar.
6. Insert wire harness into direction support / trim and grommet toward storage compartment.
7. Insert throttle cable from storage compartment into grommet and direction support / trim toward handlebar.

NOTE: Throttle cable must pass over X riser.

† Phillips is a registered trademark of Phillips Screw Co.
†† Loctite is a registered trademark of Loctite Corp.

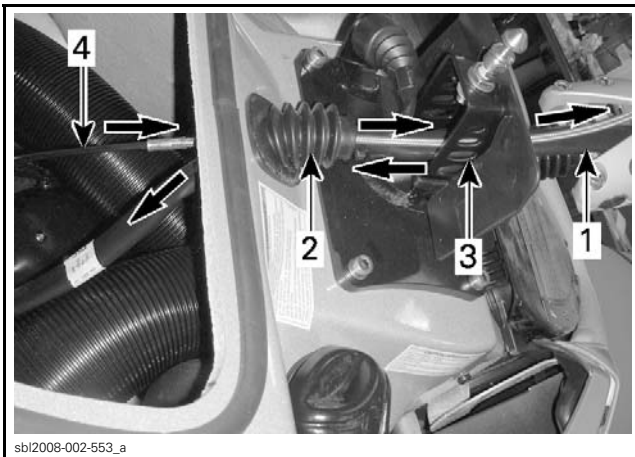

1. Wire harness
2. Grommet
3. Direction support / trim
4. Throttle cable

8. Plug-in connectors into storage compartment.

NOTE: Connectors cannot be switched up.

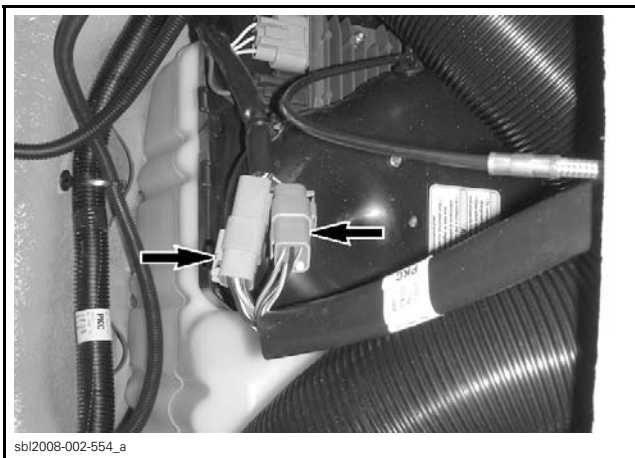

9. Connect throttle cable to throttle lever:

- 9.1 Hook cable end barrel to throttle lever.
- 9.2 Pull throttle cable sheath and install throttle cable adjustment screw into its housing.
- 9.3 Adjust as per procedure further in this bulletin.

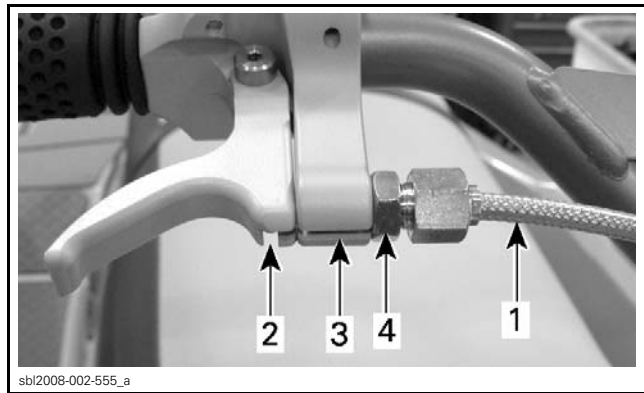

1. Throttle cable sheath
2. Cable end barrel
3. Housing
4. Throttle cable adjustment screw

All Models

10. Attach steering cable end to steering stem arm and secure with the M6 x 30 hexagonal bolt (P/N 211 000 081) from predelivery kit, Apply Loctite 243 (blue – threadlocker) on bolt threads.

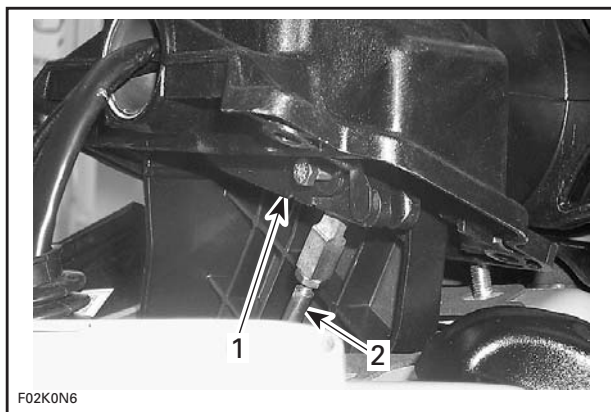

1. Steering stem arm
2. Steering cable end

11. Torque to 5 N•m (44 lbf•in).

NOTE: Ensure threads protrude through elastic nuts.

12. Secure steering assembly with 4 M8 flat washers (P/N 234 081 600) and 4 M8 elastic nuts (P/N 232 581 200) from predelivery kit.

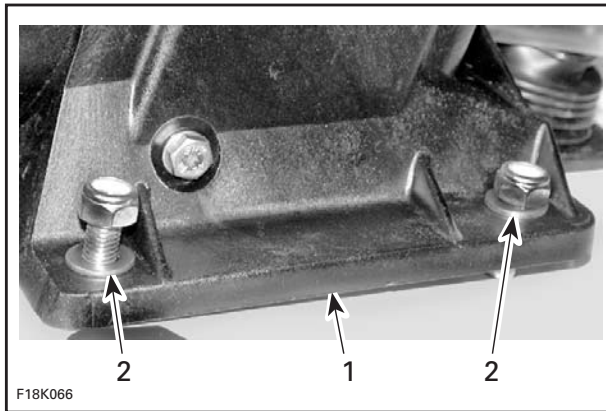

1. Steering assembly
2. M8 flat washers (P/N 234 081 600)

13. Torque to 12 N•m (106 lbf•in).

14. Install direction cable support bearing:

All except X RS Models

Install bearing support (P/N 277 001 528) to cable support using 2 bolts M6 x 50 (P/N 207 065 060) and M6 flat washers (P/N 234 061 600) from pre-delivery kit.

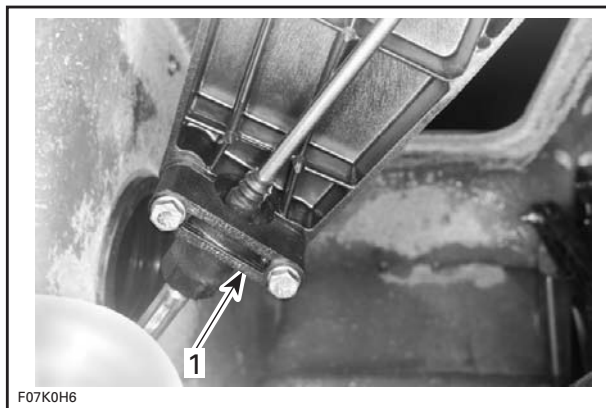

1. Bearing support (P/N 277 001 528)

X RS Models

Install bearing support (P/N 277 001 528) to cable support using U-bolt (P/N 277 001 677), M6 flat washers (P/N 234 061 600) and nuts (P/N 232 561 200), all from pre-delivery kit.

All Models

Do not torque yet; steering alignment procedure, described further in this bulletin, must be performed prior to torque bolts.

Handlegrip Installation

1. Place an insert (P/N 277 000 554) (from pre-delivery kit) into notch in handlebar.
2. Slide handle grip back in place making sure it bottoms at proper place.

3. Secure with an M6 x 30 hexagonal bolt (P/N 250 000 002) (with scotch grip) and an M6 stainless steel flat washer (P/N 240 062 600).

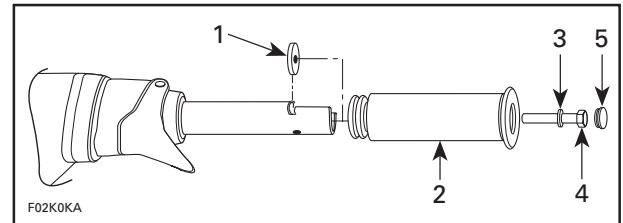

1. Insert (P/N 277 000 554)
2. Handle grip
3. M6 stainless steel flat washer (P/N 240 062 600)
4. M6 x 30 hexagonal bolt (P/N 250 000 002)
5. Rubber cap (P/N 277 000 203)

NOTICE Ensure to install flat washer otherwise screw will damage grip end.

4. Torque bolt to 7 N•m (62 lbf•in).

5. Cover bolt by inserting rubber cap (P/N 277 000 203).

Repeat steps for other side.

Throttle Cable Installation

All except X RS Models

1. Insert end of throttle cable into plastic tube leading out from steering assembly.

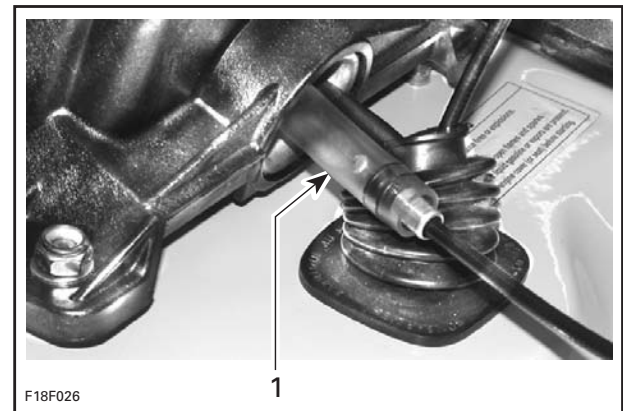

1. Plastic tube
2. Unscrew and lift throttle housing cover.

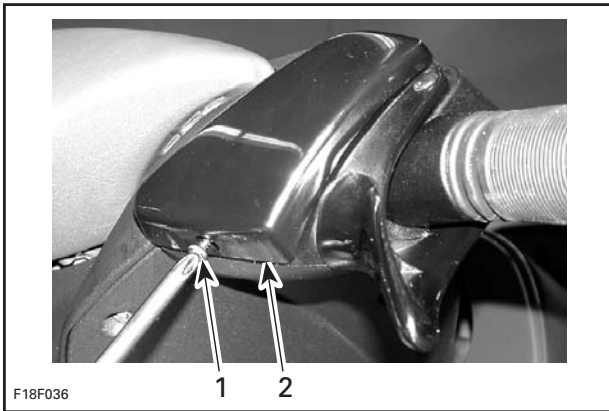

1. Unscrew
2. Throttle housing cover

From handlebar side, pull hose/cable and install throttle cable in throttle housing.

Reinstall throttle housing cover.

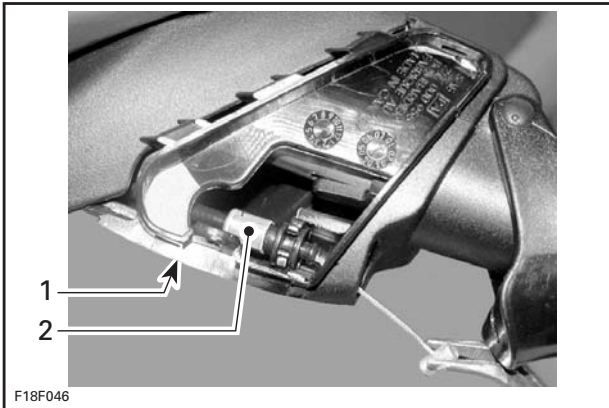

1. Throttle cable
2. Throttle housing

Install throttle cable into throttle lever.



Steering Harness Installation

All except X RS Models

1. Connect steering harness connectors to main harness connectors.

2. Secure with locking tie from predelivery kit or, in some cases, use existing locking tie attached to vent tube bracket.

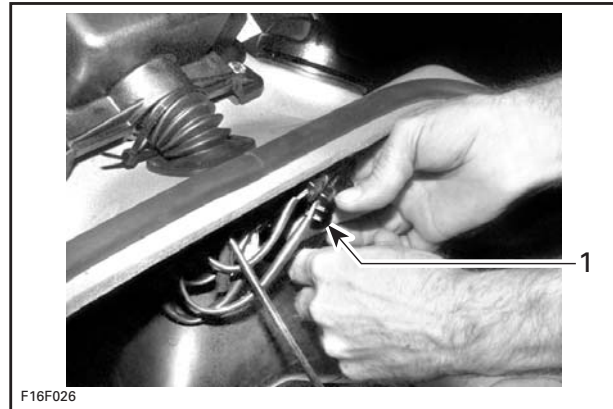

1. Connect

Steering Rubber Boot Installation

All except X RS Models

1. Position rubber boot.



Storage Cover Installation

GTX, RXP and RXP-X RS Models

1. Remove plastic wrapping over storage cover assembly.
2. Remove access cover and storage basket from storage cover assembly.
3. Secure rear arm of storage cover assembly to deck pivot support using (from predelivery kit):
 - 2 M6 x 25 hexagonal bolts (P/N 211 000 022)
 - 2 M6 flat washers (P/N 234 061 600)
 - 2 M6 elastic nuts (P/N 232 561 200).
4. Apply Loctite 243 (blue – threadlocker) on bolt threads.

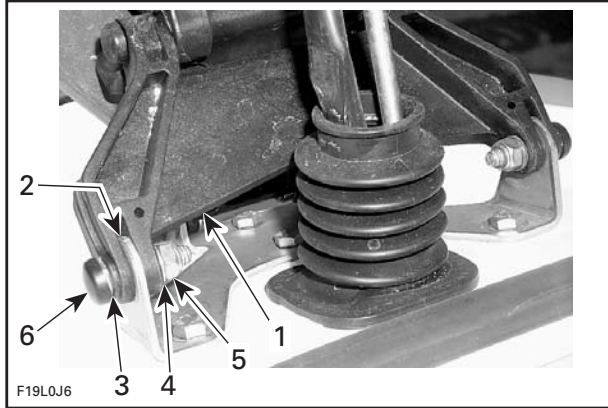

1. Storage cover assembly
2. Deck pivot support
3. M6 x 25 hexagonal bolts (P/N 211 000 022)
4. M6 flat washers (P/N 234 061 600)
5. M6 elastic nuts (P/N 232 561 200)
6. Pressure cap

5. Torque nuts to 4 N•m (35 lbf•in).
6. Cover bolt heads with pressure caps (P/N 414 136 900) from predelivery kit .
7. Secure front arm of deck pivot support to storage cover assembly with the M6 x 60 hexagonal bolt (P/N 207 066 080) from predelivery kit .
8. Apply Loctite 243 (blue – threadlocker) on bolt threads.

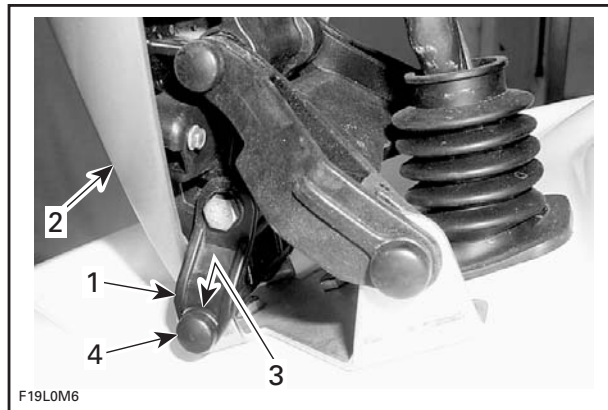

1. Deck pivot support
2. Storage cover assembly
3. M6 x 60 hexagonal bolt (P/N 207 066 080)
4. Pressure cap

9. Torque to 4 N•m (35 lbf•in).
- Cover bolt head with a pressure cap (P/N 414 136 900) from predelivery kit.

RXP and RXP-X RS Models

1. Cut locking ties holding storage cover rod to shock assembly.

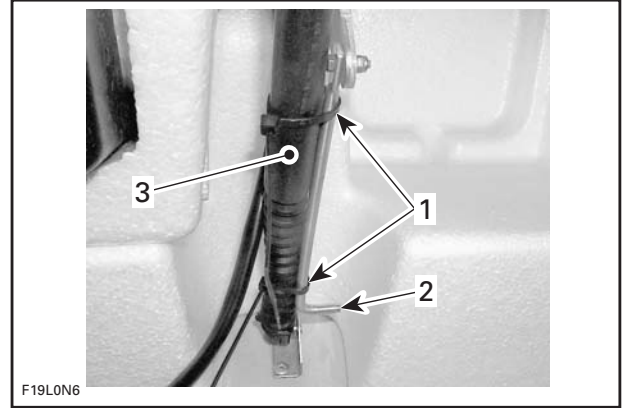

1. Locking tie
2. Storage cover rod
3. Shock assembly

2. Insert storage cover rod through deck rubber grommet.
3. Clip shock female receptacle onto bracket ball.
4. Secure storage cover rod to storage cover using:
 - an M6 flat washer (P/N 234 061 600) and
 - a circlip (P/N 293 370 005) from predelivery kit.

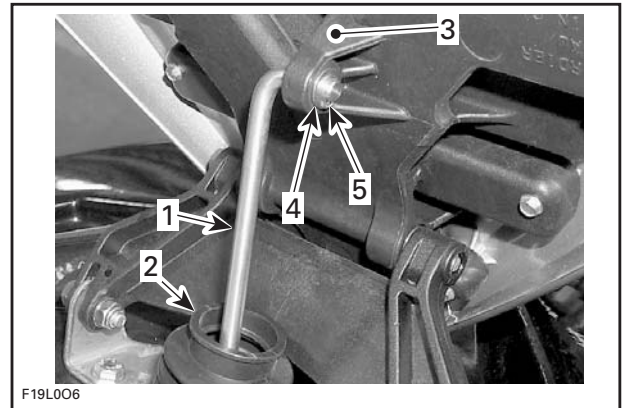

1. Storage cover rod
2. Deck rubber grommet
3. Storage cover
4. M6 flat washer (P/N 234 061 600)
5. Circlip (P/N 293 370 005)

NOTE: It may be necessary to compress shock to insert storage cover rod into storage cover, using a 1/2 inch drive ratchet.



5. Insert storage cover harness in oval hole of rubber grommet (P/N 293 720 070), from predelivery kit.
6. Secure rubber grommet on left side of storage cover rod using locking tie from predelivery kit.

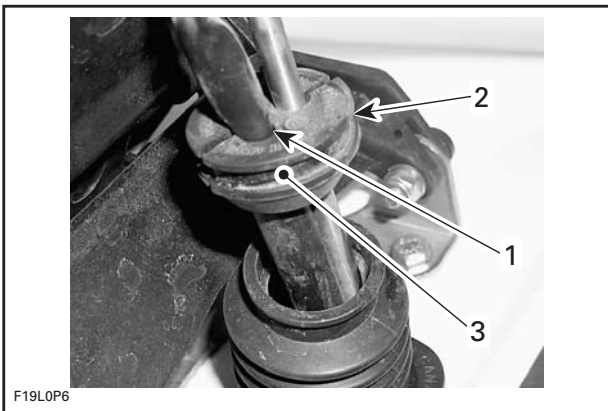

1. Storage cover harness
2. Rubber grommet
3. Locking tie

Storage Cover Shock Installation

GTX STD and Wake Models

1. Snap the top of shock (body side) in inner shell socket.
2. Place the bottom of shock (rod side) against the bump on the shock support and close storage compartment cover. The bottom of the shock will be inserted in its place automatically.

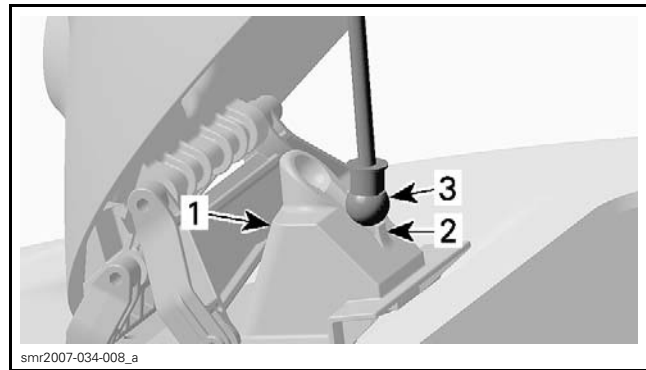

1. Shock support
2. Bump
3. Bottom of shock

Deflector Installation

GTI Models

On some models, the deflector needs to be installed.

NOTICE Deflector mounting tabs are fragile and can easily get break if the deflector is not properly installed.

⚠ WARNING

Failure to install the deflector correctly may result in severe injury for the operator and / or the passenger getting hit by the flying deflector.

1. Slip the right side tab of the deflector into the front storage cover hole.



1. Deflector right side tab

2. Slip the center tab of the deflector into the front storage cover hole toward front of watercraft.

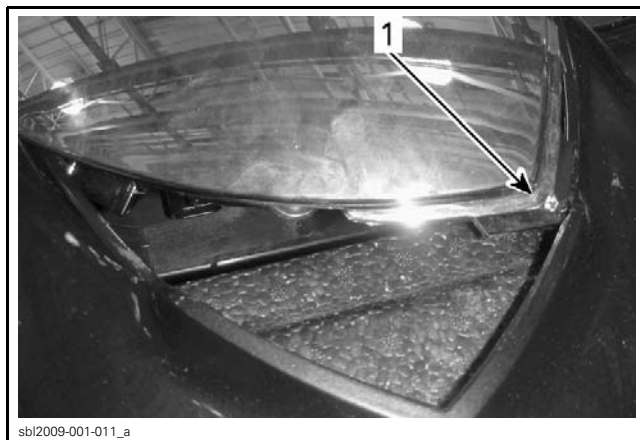

1. Deflector center tab

- Slip the left side tab of the deflector into the front storage cover hole. Push with your thumb to insert the tab into the hole.



1. Deflector left side tab

- Double-check if the deflector is correctly installed.

FINAL PREPARATION

B.U.D.S. Programming

Watercraft Identification

To enter watercraft identification or to program a safety lanyard, use BRP Utility and Diagnostic Software (B.U.D.S.) in conjunction with VCK.

The MPI-2 and DESS Post Interface can also be used.

Always use the latest B.U.D.S. version that is available from BOSSWeb (www.bossweb.brp.com) for the SEA DOO product line.

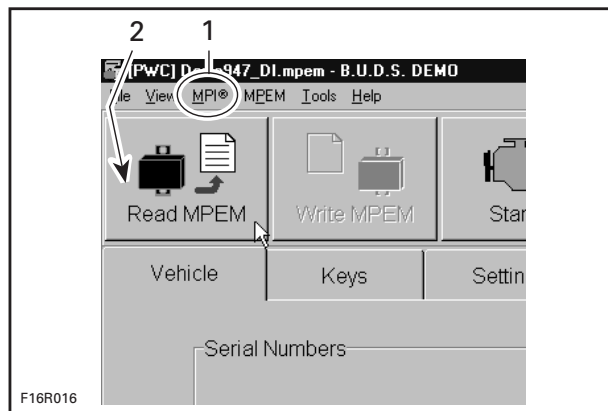

Connect the vehicle to B.U.D.S.

Choose KW2000 Protocol from Choose Protocol option in the MPI drop-down menu [1].

Read ECM using leftmost icon [2].

Click on VEHICLE tab.

Enter purchaser name in the CUSTOMER field.

Click on second icon of toolbar Write ECM to register new information from MPI memory to ECM.

Install the Correct Software in Cluster Gauge

- From B.U.D.S. go to Module, Cluster, then Update.

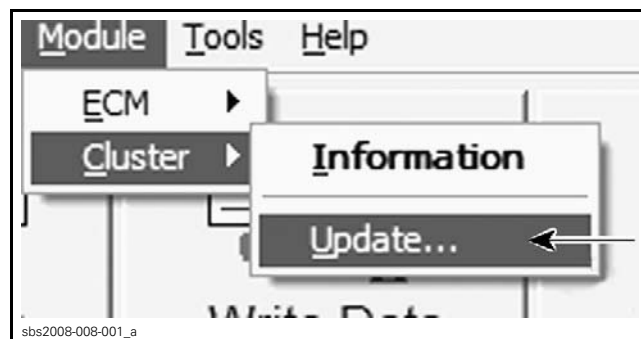

The description will tell you by model year or model number what calibration file to download (the model number and year can be found on the vehicle page under Identification).

Name	Date	Description	File Name
278 002 318 REV3	2008-03-14	MY2008 Cluster update calibration boat model 218A 218B 328A 328B	296 000 264.fc
278 002 327 REV3	2008-03-14	MY2008 Cluster update calibration boat model 338A 338B 268A 268B 188A 188B 178A 178B 178C 178D 318A 318B	296 000 264.fc
278 002 329 REV3	2008-03-14	MY2008 Cluster update calibration boat model 288A 288B	296 000 264.fc
278 002 320 REV3	2008-03-14	MY2008 Cluster update calibration boat model 148A 148B 158A 158B	296 000 264.fc
2006 Cal for 08 gauge	2007-12-12	All boat MY2006 Cluster Service parts	296 000 264.fc
2007 Cal for 08 gauge	2007-12-12	All boat MY2007 Cluster Service parts	296 000 264.fc

2. Select the file and hit OK.

NOTE: If wrong calibration is installed into the cluster, simply repeat the procedure, select the correct calibration and re-flash it.

If the cluster is not calibrated or if the wrong calibration is installed you will experience discrepancies as:

- Fuel gauge will show as empty
- All segments of the VTS will be turned on
- The RPM will indicate "0" or "5000".

NOTE: Even after the cluster is calibrated the reminder icon found on the lower R/H corner of the B.U.D.S. screen will still be seen.

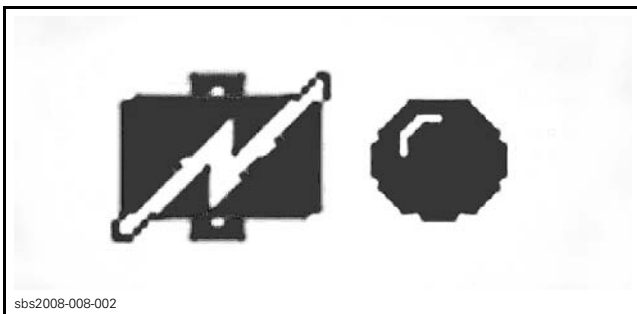

Key Programming

Refer to *SERVICE BULLETIN 2007-5* in regards to the 3 different lanyard options available on ALL 4-Tec's.

NOTE: Only 2 lanyards are shipped per watercraft. All models to the exception of the GTI R are shipped with Standard key and Learning key. The GTI R is shipped with the Standard key and the R key.

1. Click on KEYS tab.

- 1.1 If key to be added is a Learning key (white key), click on ADD LEARNING KEK button on bottom of screen.

- 1.2 If key to be added is a R key (orange key), click on ADD R KEY button on bottom of screen.

- 1.3 If key to be added is a Normal key (yellow key), click on ADD NORMAL KEY button on bottom of screen.

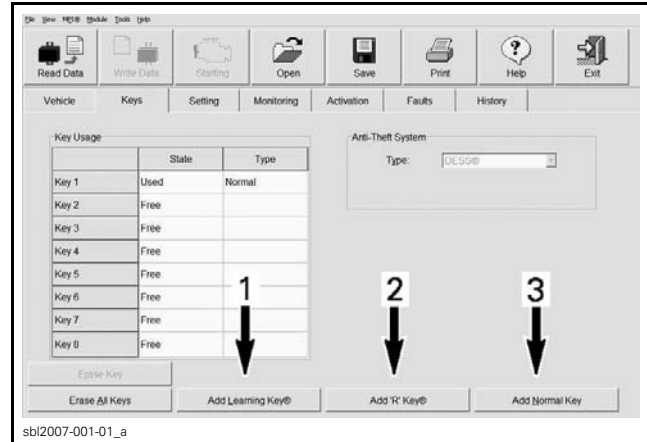

1. ADD LEARNING KEY
2. ADD R KEY
3. ADD NORMAL KEY

2. Install key on MPI or DESS post interface.

A new key is now saved in the computer.

Ensure to save new data in ECM using WRITE DATA button.

NOTICE Ensure to program keys as per bulletin 2007-5.

Cluster Language / Scale Settings

1. In B.U.D.S., select "Settings", then "Page 2" to choose cluster language and scale settings (speedometer in miles or kilometers).

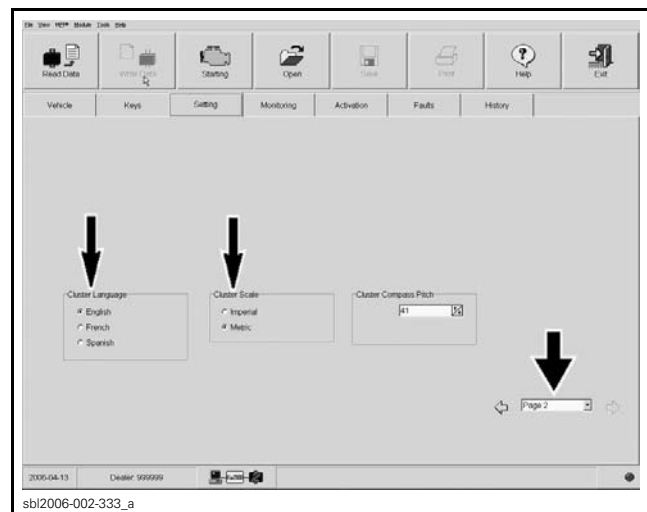

Ending a B.U.D.S. Session

1. Click on FAULT tab and check if there are active faults.

- If so, service watercraft then clear the faults in B.U.D.S.

NOTICE After a problem has been solved, ensure to clear fault(s) in ECM using the VCK. This will properly reset appropriate counter(s). This will also records that problem has been fixed in ECM memory.

- Click on WRITE DATA button to transfer new settings and information.
- Click on EXIT button (rightmost) to end session.
- Ensure to reinstall cap over the communication connector.

Fuel

- Verify fuel line connectors prior to powering-up ECM. This verification must be done visually as well as manually by physically checking each connection.

⚠ WARNING

Never add fuel prior to checking fuel line connector tightness.

NOTE: A special intake manifold gasket is supplied to lower engine power on rental units in countries where required by law.

Adding Fuel

At predelivery, we suggest dealers to fill fuel tank with recommended fuel type as described in *SPECIFICATIONS TABLE*.

NOTICE Never add oil in fuel. Never use fuel containing more than 10% alcohol (ethanol or methanol).

⚠ WARNING

Fuel is flammable and explosive under certain conditions. Always work in a well ventilated area.

Fuel System Pressurization

⚠ WARNING

A pressure test must be done before starting engine.

For fuel system pressure test procedure, refer to appropriate *SHOP MANUAL*.

It might be necessary to remove and install safety lanyard 2 or 3 times to initially feed fuel system.

NOTE: This procedure should be explained to purchaser at delivery.

Engine Oil Level

NOTE: Engine is factory filled with oil.

Verify oil level using following procedure:

NOTICE If watercraft is not in water, make sure to cool engine using flush kit, otherwise, engine, drive line and/or exhaust system may be severely damaged. Refer to FLUSHING in the *(OPERATOR'S GUIDE)* and follow procedure.

When using flush kit, never run engine for more than 5 minutes; drive line seal has no cooling when watercraft is out of water; severe damage may occur.

- Warm-up engine then let idle for 30 seconds before stopping.
- Stop engine.
- Wait at least 30 seconds then pull dipstick out and wipe clean.

⚠ CAUTION Engine oil may be hot. Certain components in engine compartment may be very hot. Direct contact may result in skin burn.

- Reinstall dipstick, push in completely.
- Remove dipstick and read oil level. It should be between marks.
 - Mark [1] for FULL.
 - Mark [2] for ADD.

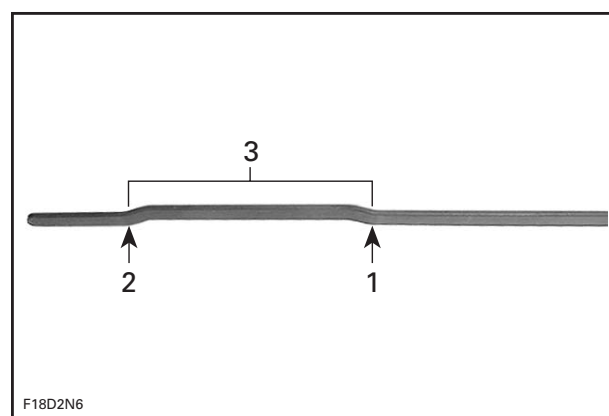

- FULL
- ADD
- Operating range

- To add oil, unscrew oil cap.

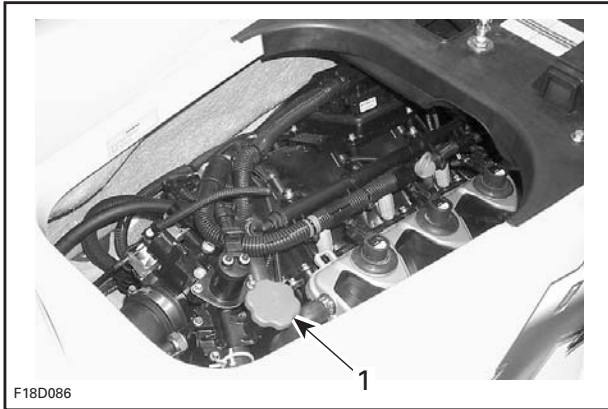

1. Oil cap

- Place a funnel into opening and add recommended oil to proper level.

NOTE: Every time oil is added in engine, the complete procedure explained previously must be done (engine restarted, idling for 30 seconds, 30 seconds waiting time and then, rechecking the oil level). Otherwise, you will have a false oil level reading.

NOTICE Do not overfill

- Properly reinstall oil cap and dipstick.

Recommended Engine Oil

Use XPS SUMMER GRADE OIL (P/N 293 600 121).

130 and 155 Engines

If the XPS engine oil is not available, use a 5W 40 engine oil meeting the requirements for API service classification SM, SL or SJ. Always check the API service label certification on the oil container, it must contain at least one of the above standards.

215 and 255 Engines

If XP-S engine oil is not available, use a 5W 40 engine oil compatible with wet clutches.

NOTE: The XPS engine oil has been thoroughly tested to be free of any additives that could impair the functionality of the supercharger clutch.

NOTICE Do not use an engine oil meeting the requirement for API service classification SM or SL. Using a lubricant not compatible with wet clutches will impair the proper operation of the supercharger clutch. Do not add any additives to the recommended oil.

Engine Coolant Level

⚠ WARNING

Check coolant level with engine cold. Never add coolant in cooling system when engine is hot.

- Remove seat or seat extension to expose cooling system expansion tank.

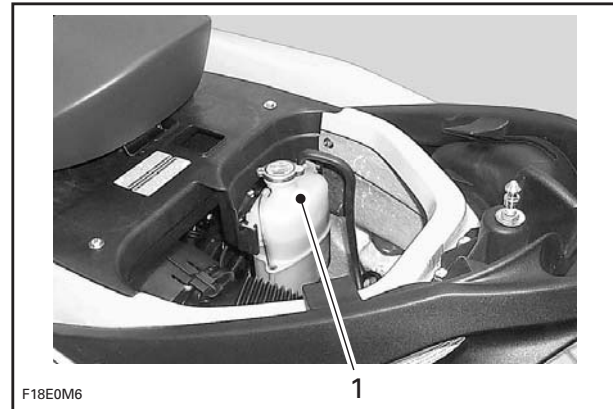

1. Expansion tank

- With vehicle on a level surface, liquid should be between MIN. and MAX. level marks of coolant reservoir when engine is cold.

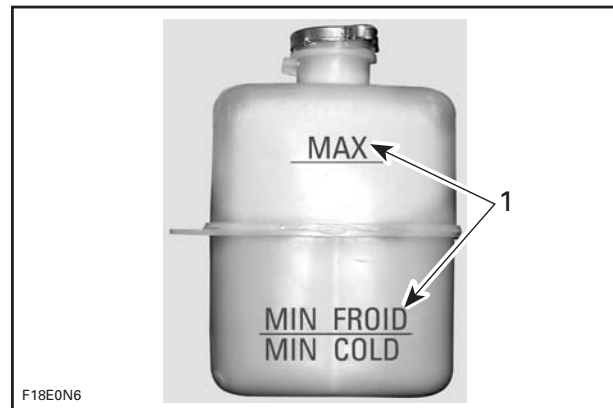

1. MIN. and MAX. level marks

NOTE: Watercraft is leveled when it is in water. When on a trailer, raise trailer tongue and block in this position when bumper rail is leveled.

- Add coolant to have level between marks as required.

Use a funnel to avoid spillage.

NOTE: Use recommended coolant type as described in the Specifications table.

NOTICE Do not overfill.

- Properly reinstall and tighten filler cap then reinstall seat.

Recommended Engine Coolant

Always use ethylene-glycol antifreeze containing corrosion inhibitors specifically for internal combustion aluminum engines.

NOTE: When available, it is recommended to use biodegradable antifreeze compatible with internal combustion aluminum engines. This will contribute to protect the environment.

Cooling system must be filled with water and antifreeze solution (50% demineralized water, 50% antifreeze).

BRP sells premixed coolant with freezing protection up to -37°C (-35°F) (P/N 293 600 038).

To prevent antifreeze deterioration, always use the same brand. Never mix different brands unless cooling system is completely flushed and refilled. Refer to an authorized Sea-Doo dealer.

Steering Alignment

Steering Alignment Verification

1. Position handlebar in straight ahead position by measuring each side the distance from handlebar grip end to floorboard.

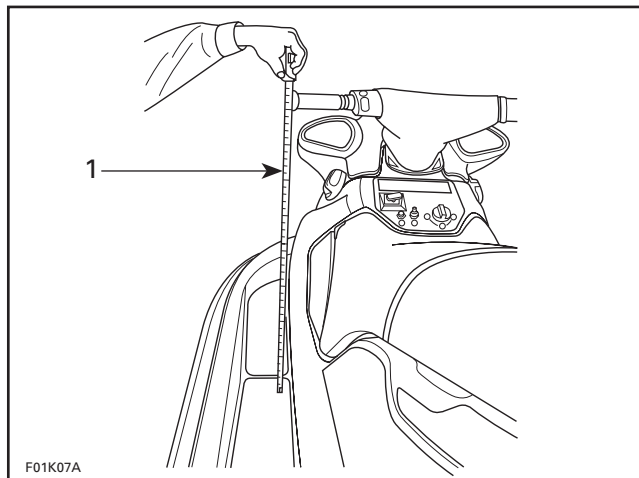

1. Measuring distance

2. Check jet pump nozzle position by placing a straight edge on nozzle outer end.
3. Measure the distance on each side of the straight edge; it must be equal.

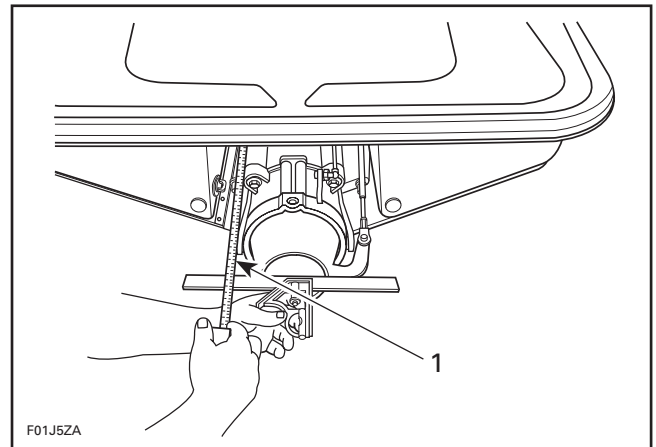

1. Measuring distance

4. If necessary, steering alignment adjustment should be performed at steering cable support.

Steering Alignment Adjustment

All Models except GTI Series

1. Open storage compartment cover and remove basket.

RXP

1. Remove front vent tube to allow room.

GTI Series

1. Remove the glove box.

All Models

2. Loosen bolts securing the retaining block at the bottom of cable support.
3. Turn adjustment nut as required.

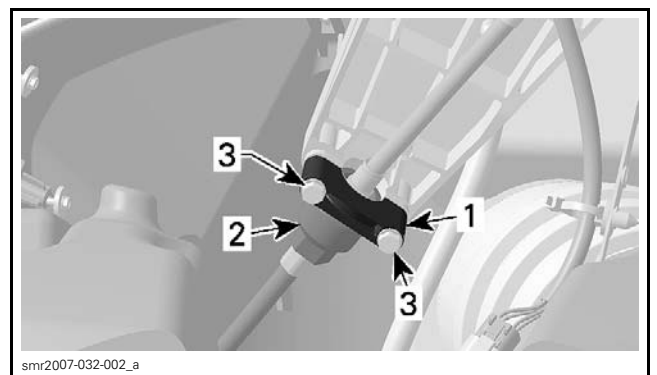

1. Block
2. Adjustment nut
3. Bolts

4. After adjustment, torque retaining block bolts to $6\text{ N}\cdot\text{m}$ ($53\text{ lbf}\cdot\text{in}$).

NOTICE Verify when the handlebar is turned completely to the left or right side, that there is no interference with venturi, O.P.A.S. or VTS ring.

O.P.A.S.™ System Alignment

All adjustments have already been performed at factory. If readjustments are needed, check O.P.A.S. system alignment procedure in appropriate *SHOP MANUAL*.

Throttle Cable Adjustment

Verify adjustment of throttle cable as follows.

1. Throttle lever must reach handlebar grip without causing strain to cable or cable bracket.

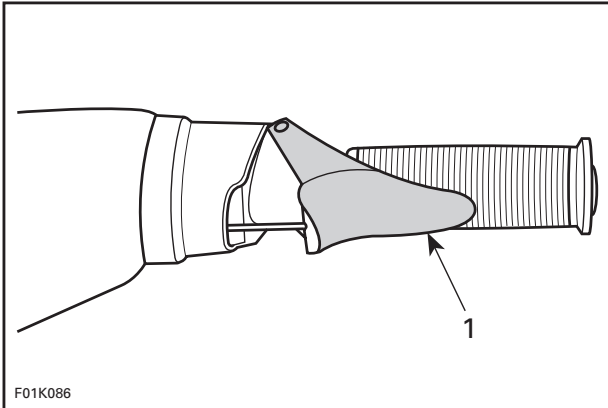

1. Throttle lever

2. With throttle lever in full throttle position, throttle lever stopper should almost contact throttle body.
3. To verify that there is free play, apply a light pressure on throttle plate(s), a slight play should be obtained.
4. With throttle lever released, it must have a free play of 1 - 3 mm (0.04 - 0.120 in) in cable.

NOTICE Improper cable adjustment will cause strain on cable and/or damage cable bracket or throttle lever at handlebar.

To adjust throttle cable, loosen jam nut then turn adjustment nut as necessary.

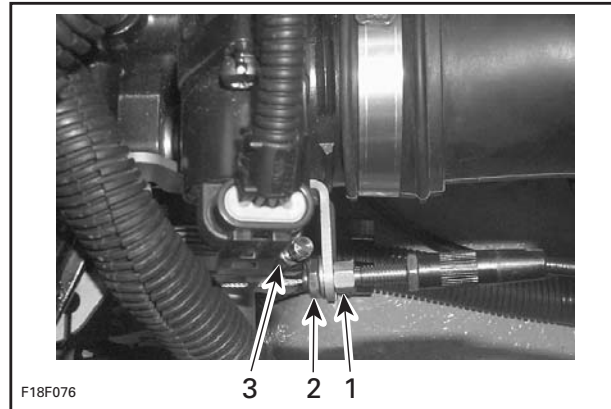

1. Adjustment nut
2. Jam nut
3. Idle speed screw

⚠ WARNING

Make sure idle speed screw contacts throttle cam when throttle lever is fully released at handlebar.

NOTICE Never attempt to adjust idle speed through throttle body tamper proof screw. If so, it would impair idle speed stability. Besides, no adjustment could be performed by dealer nor factory to correct idle speed. Throttle body would need to be replaced. Also take into account that it might change engine emission level and engine might not meet EPA/CARB requirements.

For more informations on throttle cable adjustment, refer to appropriate Sea-Doo *SHOP MANUAL*.

Protective Films Removal

Protective film on all decals must be removed.

1. Slowly peel off protective films.

Final Inspection

1. Complete *PREDELIVERY CHECK LIST* following all instructions.
2. Test ride watercraft.

Watercraft Cleaning

1. Clean watercraft.

NOTICE Clean apparent fiberglass and plastic parts with a clean cloth and soapy water or isopropyl alcohol. Never use strong detergent, degreasing agent, paint thinner, acetone, etc. Do not apply isopropyl alcohol directly on decals.

DELIVERY TO CUSTOMER

Vehicle Delivery

1. Where possible, give a brief demo ride and explain watercraft operation.
2. Explain, complete and return WARRANTY REGISTRATION CARD (legal requirement).
3. Customer must sign *PREDELIVERY CHECK LIST*.
4. Give to customer:
 - Operator's guide
 - Safety DVD
 - Copy of the *PREDELIVERY CHECK LIST*.

Fuel System

Explain to purchaser that it might be necessary to remove and install safety lanyard 2 or 3 times to initially feed fuel system.

Handlebar Tag

A tag is tied to handlebar. Leave it there until delivery and make sure purchaser reads it.

Break-In Period

Explain to purchaser that with Sea-Doo watercraft powered by Rotax® engines, a break-in period of 10 hours is required before continuous operation at full throttle.

To achieve a good break-in, vary engine speed every few minutes with brief wide open throttle accelerations of up to 15 seconds.

NOTICE Continued wide open throttle runs and prolonged cruising without speed variations should be avoided, this can cause engine damage during break-in period.

Accessories

On some models, accessories, such as wakeboard rack, ballast tanks kit, etc., must be installed prior to delivering vehicle. Refer to appropriate *OPERATOR'S MANUAL* for complete installation procedure.

SPECIFICATIONS

GTI Models

VEHICLE		GTI 130	GTI SE 130	GTI SE 155	GTI STD R
ENGINE					
Type		Rotax® 4-TEC®. Single Over Head Camshaft (SOHC)			
		130 hp	130 hp	155 hp	130 hp
Number of cylinder		3			
Number of valve		12 valves (4 per cylinder) with hydraulic lifters (no adjustment)			
Displacement		1494 cc (91 cu. in)			
Intake system	Type	Naturally aspirated			
	Throttle body	52 mm			
Bore		100 mm (3.9 in)			
Stroke		63.4 mm (2-1/2 in)			
Compression ratio		10.6:1			
Cooling		Closed-loop system			
ELECTRICAL SYSTEM					
Ignition		Digital inductive			
Starter		Electric			
Battery		12 V, 30 A•h. Electrolyte type			
Spark plug	Make and type	NGK, DCPR8E			
	Gap	0.75 mm (.030 in)			
PROPULSION					
Propulsion system		Sea-Doo® direct drive			
Jet pump	Type	Axial flow, single stage. Large hub with 10-vane stator			
	Material	Aluminum			
Transmission		Direct drive, forward/neutral/reverse			
Impeller		Stainless steel			
DIMENSIONS AND WEIGHT					
Length		322.5 cm (127 in)			
Width		124.5 cm (49 in)			
Height		117 cm (45.9 in)			
Weight (dry)		332 kg (732 lb)	338.8 kg (747 lb)	338.8 kg (747 lb)	332 kg (732 lb)
Rider capacity (refer to load limit)		1, 2 or 3			
Storage capacity		46.8 L (12.4 U.S. gal)			
Load limit (passengers + luggage)		273 kg (600 lb)			
FLUIDS					
Fuel	Type	Unleaded			
	Minimum octane	92 RON			
	Tank capacity	60 L (15.9 U.S. gal)			
Engine oil	Type	XP-S summer grade.			
	Capacity	3 L (2.7 U.S. qt) oil change w/filter 4.5 L (4.1 U.S. qt) total			
Cooling system	Coolant type	Ethylene-glycol 50%/50% antifreeze/demineralized water. Coolant containing corrosion inhibitors for internal combustion aluminum engines			
	Capacity	5.5 L (5 U.S. qt) total			

GTX Models

VEHICLE		GTX 155	GTX 215
ENGINE			
Type		Rotax® 4-TEC®. Single Over Head Camshaft (SOHC)	
		155 hp	215 hp
Number of cylinder		3	
Number of valve		12 valves (4 per cylinder) with hydraulic lifters (no adjustment)	
Displacement		1494 cc (91 cu. in)	
Intake system	Type	Naturally aspirated	Supercharged with intercooler
	Throttle body	52 mm	
Bore		100 mm (3.9 in)	
Stroke		63.4 mm (2-1/2 in)	
Compression ratio		10.6:1	8.4:1
Cooling		Closed-loop system	
ELECTRICAL SYSTEM			
Ignition		Digital inductive	
Starter		Electric	
Battery		12 V, 30 A•h. Electrolyte type	
Spark plug	Make and type	NGK, DCPR8E	
	Gap	0.75 mm (.030 in)	
PROPULSION			
Propulsion system		Sea-Doo® direct drive	
Jet pump	Type	Axial flow, single stage. Large hub with 10-vane stator	
	Material	Aluminum	
Transmission		Direct drive, forward/neutral/reverse	
Impeller		Stainless steel	
DIMENSIONS AND WEIGHT			
Length		331 cm (130.3 in)	
Width		122 cm (48 in)	
Height		120 cm (47.2 in)	
Weight (dry)		361 kg (795 lb)	366 kg (805 lb)
Rider capacity (refer to load limit)		1, 2 or 3	
Storage capacity		129.8 L (34.3 U.S. gal)	
Load limit (passengers + luggage)		273 kg (600 lb)	
FLUIDS			
Fuel	Type	Unleaded	
	Minimum octane	92 RON	95 RON
	Tank capacity	60 L (15.9 U.S. gal)	
Engine oil	Type	XP-S summer grade.	
	Capacity	3 L (2.7 U.S. qt) oil change w/filter 4.5 L (4.1 U.S. qt) total	
Cooling system	Coolant type	Ethylene-glycol 50%/50% antifreeze/demineralized water. Coolant containing corrosion inhibitors for internal combustion aluminum engines	
	Capacity	5.5 L (5 U.S. qt) total	

RXP Models

VEHICLE		RXP 215	RXP-X RS 255
ENGINE			
Type		Rotax® 4-TEC®. Single Over Head Camshaft (SOHC)	
		215 hp	255 hp
Number of cylinder		3	
Number of valve		12 valves (4 per cylinder) with hydraulic lifters (no adjustment)	
Displacement		1494 cc (91 cu. in)	
Intake system	Type	Supercharged with intercooler	Supercharged with external intercooler
	Throttle body	52 mm	
Bore		100 mm (3.9 in)	
Stroke		63.4 mm (2-1/2 in)	
Compression ratio		8.4:1	
Cooling		Closed-loop system	
ELECTRICAL SYSTEM			
Ignition		Digital inductive	
Starter		Electric	
Battery		12 V, 30 A•h. Electrolyte type	
Spark plug	Make and type	NGK, DCPR8E	
	Gap	0.75 mm (.030 in)	
PROPULSION			
Propulsion system		Sea-Doo® direct drive	
Jet pump	Type	Axial flow, single stage. Large hub with 10-vane stator	
	Material	Aluminum	
Transmission	Type	Direct drive, forward/neutral/reverse	
	VTS	Electric	
Impeller		Stainless steel	
DIMENSIONS AND WEIGHT			
Length		307 cm (121 in)	
Width		122 cm (48 in)	
Height		118 cm (46.6 in)	116 cm (45.8 in)
Weight (dry)		359 kg (792 lb)	361 kg (795 lb)
Rider capacity (refer to load limit)		1 or 2	
Storage capacity		40.3 L (10.7 U.S. gal)	
Load limit (passengers + luggage)		181 kg (399 lb)	
FLUIDS			
Fuel	Type	Unleaded	
	Minimum octane	95 RON	
	Tank capacity	60 L (15.9 U.S. gal)	
Engine oil	Type	XP-S summer grade.	
	Capacity	3 L (2.7 U.S. qt) oil change w/filter 4.5 L (4.1 U.S. qt) total	
Cooling system	Coolant type	Ethylene-glycol 50%/50% antifreeze/demineralized water. Coolant containing corrosion inhibitors for internal combustion aluminum engines	
	Capacity	5.5 L (5 U.S. qt) total	

RXT Models

VEHICLE		RXT 215	RXT-X RS 255
ENGINE			
Type		Rotax® 4-TEC®. Single Over Head Camshaft (SOHC)	
		215 hp	255 hp
Number of cylinder		3	
Number of valve		12 valves (4 per cylinder) with hydraulic lifters (no adjustment)	
Displacement		1494 cc (91 cu. in)	
Intake system	Type	Supercharged with intercooler	Supercharged with external intercooler
	Throttle body	52 mm	
Bore		100 mm (3.9 in)	
Stroke		63.4 mm (2-1/2 in)	
Compression ratio		8.4:1	
Cooling		Closed-loop system	
ELECTRICAL SYSTEM			
Ignition		Digital inductive	
Starter		Electric	
Battery		12 V, 30 A•h. Electrolyte type	
Spark plug	Make and type	NGK, DCPR8E	
	Gap	0.75 mm (.030 in)	
PROPULSION			
Propulsion system		Sea-Doo® direct drive	
Jet pump	Type	Axial flow, single stage. Large hub with 10-vane stator	
	Material	Aluminum	
Transmission	Type	Direct drive, forward/neutral/reverse	
	VTS	—	Electric
Impeller		Stainless steel	
DIMENSIONS AND WEIGHT			
Length		331 cm (130 in)	
Width		122 cm (48 in)	
Height		120 cm (47.2 in)	118 cm (46.5 in)
Weight (dry)		370 kg (815 lb)	372 kg (818 lb)
Rider capacity (refer to load limit)		1, 2 or 3	
Storage capacity		129.8 L (34.3 U.S. gal)	123 L (32.5 U.S. gal)
Load limit (passengers + luggage)		273 kg (600 lb)	
FLUIDS			
Fuel	Type	Unleaded	
	Minimum octane	95 RON	
	Tank capacity	60 L (15.9 U.S. gal)	
Engine oil	Type	XP-S summer grade.	
	Capacity	3 L (2.7 U.S. qt) oil change w/filter 4.5 L (4.1 U.S. qt) total	
Cooling system	Coolant type	Ethylene-glycol 50%/50% antifreeze/demineralized water. Coolant containing corrosion inhibitors for internal combustion aluminum engines	
	Capacity	5.5 L (5 U.S. qt) total	

Wake Models

VEHICLE		WAKE 155	WAKE PRO 215
ENGINE			
Type		Rotax® 4-TEC®. Single Over Head Camshaft (SOHC)	
		155 hp	215 hp
Number of cylinder		3	
Number of valve		12 valves (4 per cylinder) with hydraulic lifters (no adjustment)	
Displacement		1494 cc (91 cu. in)	
Intake system	Type	Naturally aspirated	Supercharged with intercooler
	Throttle body	52 mm	
Bore		100 mm (3.9 in)	
Stroke		63.4 mm (2-1/2 in)	
Compression ratio		10.6:1	8.4:1
Cooling		Closed-loop system	
ELECTRICAL SYSTEM			
Ignition		Digital inductive	
Starter		Electric	
Battery		12 V, 30 A•h. Electrolyte type	
Spark plug	Make and type	NGK, DCPR8E	
	Gap	0.75 mm (.030 in)	
PROPULSION			
Propulsion system		Sea-Doo® direct drive	
Jet pump	Type	Axial flow, single stage. Large hub with 10-vane stator	
	Material	Aluminum	
Transmission		Direct drive, forward/neutral/reverse	
Impeller		Stainless steel	
DIMENSIONS AND WEIGHT			
Length		323 cm (127 in)	331 cm (130.3 in)
Width		125 cm (49 in)	122 cm (48 in)
Height		117 cm (45.9 in)	120 cm (47.2 in)
Weight (dry)		339 kg (748 lb)	388 kg (853 lb)
Rider capacity (refer to load limit)		1, 2 or 3	
Storage capacity		46.8 L (12.4 U.S. gal)	129.8 L (34.3 U.S. gal)
Load limit (passengers + luggage)		273 kg (600 lb)	
FLUIDS			
Fuel	Type	Unleaded	
	Minimum octane	92 RON	95 RON
	Tank capacity	60 L (15.9 U.S. gal)	
Engine oil	Type	XP-S summer grade.	
	Capacity	3 L (2.7 U.S. qt) oil change w/filter 4.5 L (4.1 U.S. qt) total	
Cooling system	Coolant type	Ethylene-glycol 50%/50% antifreeze/demineralized water. Coolant containing corrosion inhibitors for internal combustion aluminum engines	
	Capacity	5.5 L (5 U.S. qt) total	