



Date : **February 23 2011** Subject : **Service Tools** No 2011-2 Rev 1

Year	Model
All	All

BRP is proud to introduce its latest Service Tools Bulletin. These special tools were designed to help you efficiently service BRP vehicles. Please always make sure to use special tools along with the appropriate Shop Manual(s) and respect all safety measures.

Mandatory Tools: These tools are absolutely needed to perform certain service procedures. They will be automatically shipped to dealerships. They do not need to be ordered separately.

Recommended Tools: These tools will facilitate the Technicians work. They will not be automatically shipped to dealerships. They need to be ordered separately.

Table of contents

Tools by System:

Engine	P	2
Fuel	P	4
Cooling	P	4
Electrical	P	5
Lubrication	P	6
Transmission / Propulsion	P	6
Brake	P	7
Steering	P	8
Suspension	P	8
Various	P	9

Index of tools by Part Number:	P	11
---	---	----

Engine



Vacuum/pressure pump
P/N 529 021 800 Recommended
 All models



Engine leak down test kit
P/N 529 035 661 Recommended
 All 4-stroke engines
 To perform a leak down test on engine.

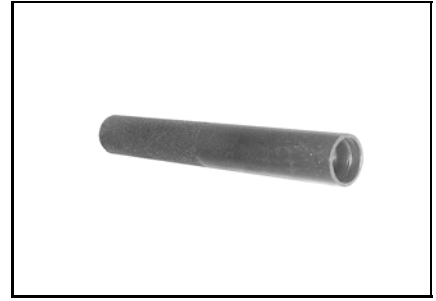

Valve stem seal installer
P/N 529 035 687 Recommended
 1503, 991 engine



Valve spring compressor
P/N 529 035 724 Recommended
 4-TEC engines
 To be used with valve spring compressor cup 529 035 764 and 529 036 073

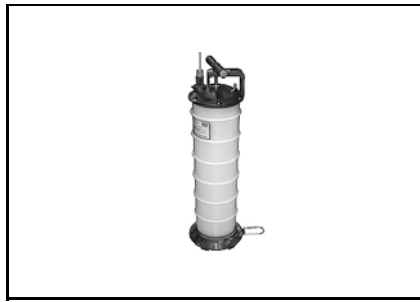

Suction pump
P/N 529 035 880 Recommended



Oil seal installer
P/N 529 035 933 Recommended
 449/991 engines, Outlander 330/400
 Use with handle 420 877 650 Same usage as 529 036 069.

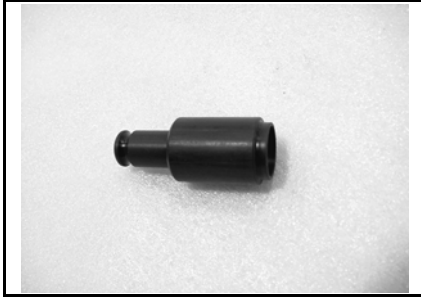

Oil seal installer
P/N 529 036 069 Recommended
 449/991 engines, Outlander 330/400
 Use with handle 420 877 650
 Same usage as 529 035 933.



Piston circlip installer 991
P/N 529 036 072 Recommended
 991



Valve spring compressor cup
P/N 529 036 073 Recommended
 449/500/610/991/503
 To be used with 529 035 724

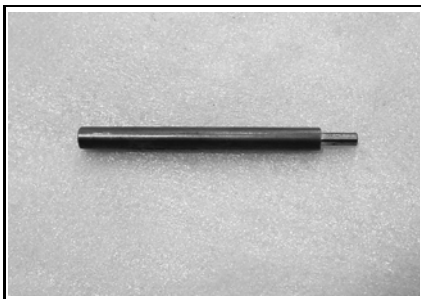

Valve guide remover (6 mm)
P/N 529 036 074 Recommended
 449, 991 engines
 Valve guide pusher



Valve guide installer (6 mm)
P/N 529 036 075 Recommended
 449, 991 engines
 Valve guide insertion jig



Crankcase seal pusher
P/N 529 036 092 Recommended
 991

Engine

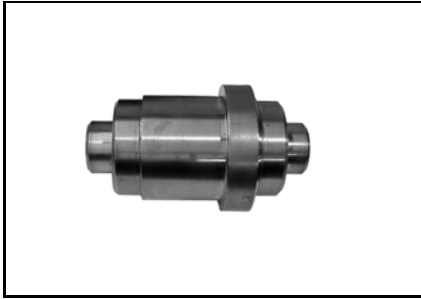

Cranshaft plain bearing tool
P/N 529 036 093 Recommended
 991
 plain bearing

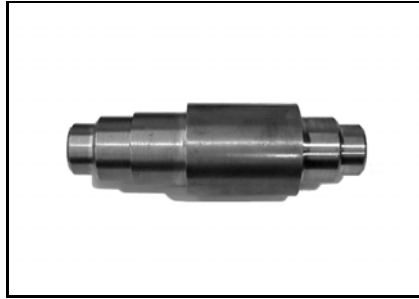

Balance shaft plain bearing rem/inst
P/N 529 036 094 Recommended
 991

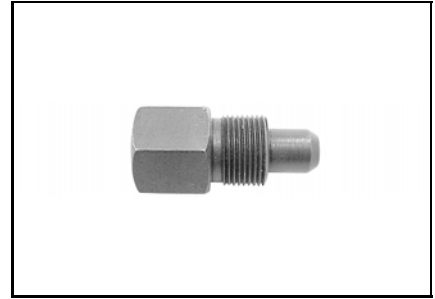

Magneto puller
P/N 529 036 097 **Mandatory**
 991



Puller/locking tool
P/N 529 036 098 **Mandatory**
 610/500, 991, V-490, V-660, V-810, V-1010

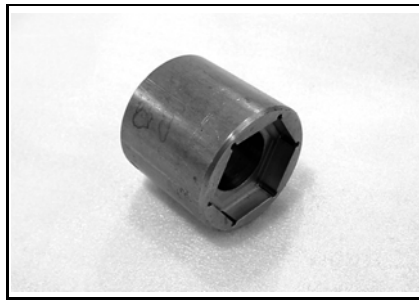

Socket 46 mm machined
P/N 529 036 114 **Mandatory**
 991



Main shaft protector
P/N 529 036 123 Recommended
 991



Main shaft seal pusher
P/N 529 036 124 Recommended
 991

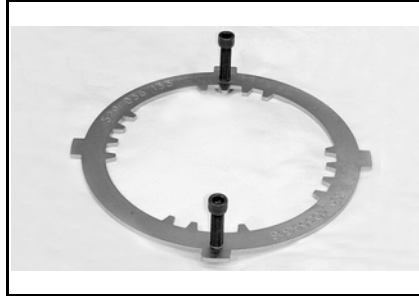

Clutch assembly holder
P/N 529 036 133 **Mandatory**
 991 engines



Engine lifting tool
P/N 529 036 181 Recommended
 991



Piston ring compressor
P/N Snap-on RC 980 Recommended
 4-TEC
 Not sold by BRP

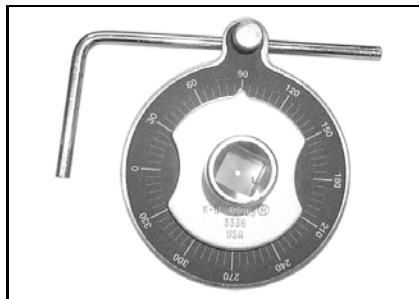

Torque angle gauge
P/N Snap-on TA362 Recommended
 Used on most 4-stroke engines
 Not sold by BRP

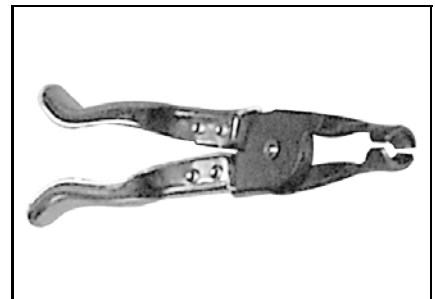

Valve stem seal removal plier
P/N Snap-on YA 8230 Recommended
 1503, 991 engines, DS650
 Not sold by BRP

Fuel



Pressure gauge

P/N 529 035 709

Mandatory

Injection type engines

Use with 529035652, 529035714 and 529036023



Disconnect tool

P/N 529 035 714

Mandatory

Injection models

Used also with gauge P/N 529 035 709, 529 035 652 and 529 036 023

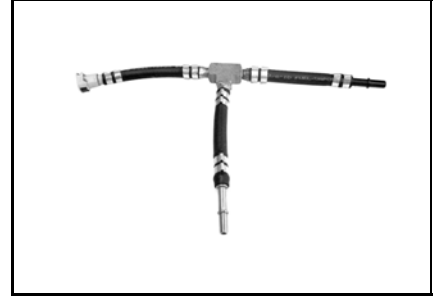

Fuel hose adapter

P/N 529 036 023

Mandatory

Injection type vehicles

To be used with 529 035 709.
Replacement clip 513 033 135



Throttle body synchronizer

P/N carb tune pro

Recommended

Roadster



Throttle body synchronizer

P/N Motion_Pro

Recommended

Roadster

Motion Pro or equivalent

Cooling



Test cap

P/N 529 035 991

Recommended

All models

To be used with vacuum/pressure pump 529 021 800.



Water pump seal pusher (housing)

P/N 529 036 089

Recommended

991

Electrical

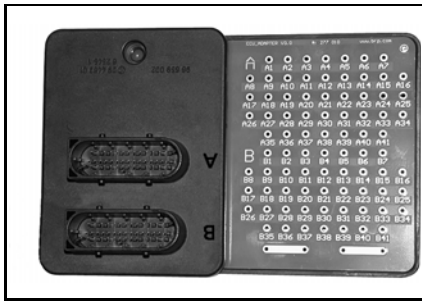

ECM adapter tool
P/N 420 277 010 **Mandatory**
 All models
 All injected 2-TEC & 4-TEC with VDO ECM

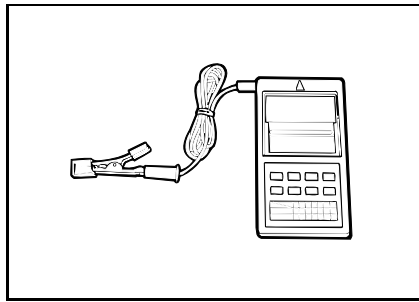

Digital induction tachometer
P/N 529 014 500 Recommended
 All models



MPI-2 communication cable extension
P/N 529 035 697 Recommended
 Male/female DB9 extension can be purchased at any PC store; max. 25 ft lg.



Crimping tool (heavy gauge wire)
P/N 529 035 730 Recommended
 All models
 Ex.: To crimp battery cable terminals.



Fluke 115 multimeter
P/N 529 035 868 Recommended
 All models

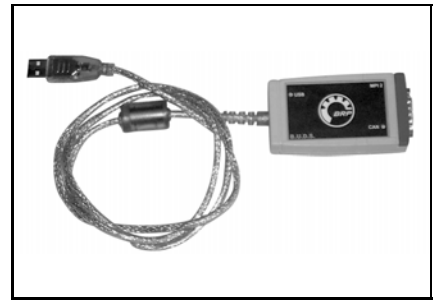

MPI-2 interface card
P/N 529 036 018 **Mandatory**
 Replaces the MPI.

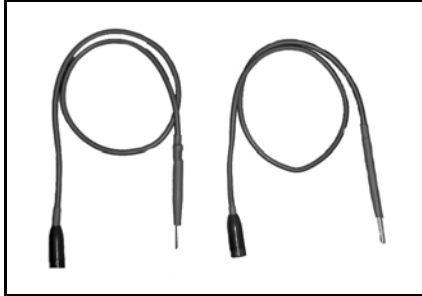

Back probe test wires
P/N 529 036 063 Recommended
 All models
 To back probe various connectors.

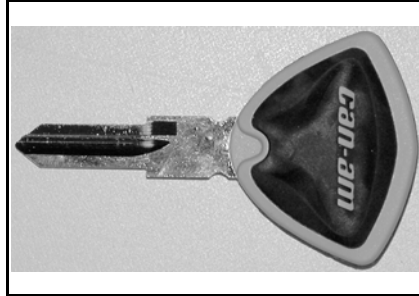

Master key
P/N 529 036 106 **Mandatory**
 Roadster



ECM adapter tool
P/N 529 036 166 **Mandatory**
 ECM BOSCH



ECM terminal remover 3.36
P/N 529 036 174 Recommended
 All models



ECM terminal remover 2.25
P/N 529 036 175 Recommended
 All models

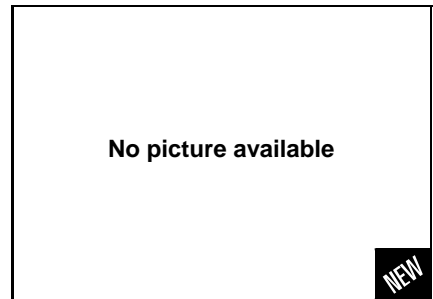

Spanner tool
P/N 529 036 223 **Mandatory**
 Roadster

Electrical

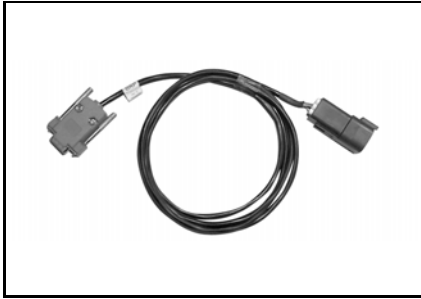

MPI-2 diagnostic cable

P/N 710 000 851

Mandatory

All D.E.S.S. equipped vehicles

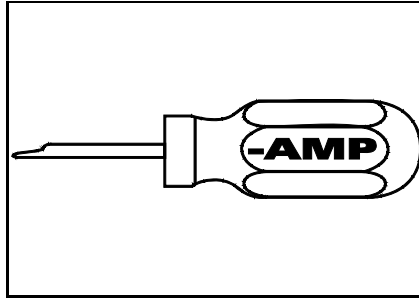

Multilock terminal extraction tool

P/N AMP 755430-2 Recommended

Not sold by BRP

Lubrication



Adapter hose

P/N 529 035 652

Mandatory

4-stroke engines

Used with 529 035 709.

Transmission / Propulsion



Main shaft seal installer

P/N 529 036 088

Recommended

991

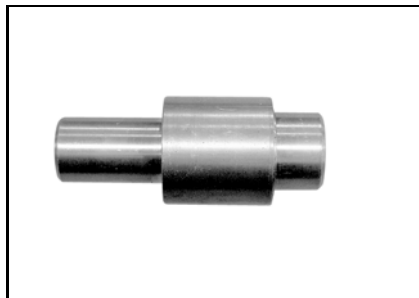

Clutch cover bearing installer

P/N 529 036 095

Recommended

991

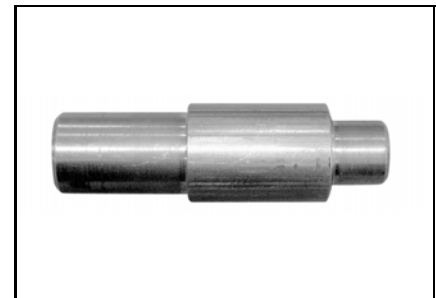

Clutch cover bearing installer

P/N 529 036 096

Recommended

991

Transmission / Propulsion



Socket spanner

P/N 529 036 113

Mandatory

Roadster
Rear wheel internal screw



Belt tension meter

P/N 529 036 115

Mandatory

Roadster
Belt adjustment



Oil pressure gauge

P/N 529 036 142

Mandatory

991
Used for SE5 transmission

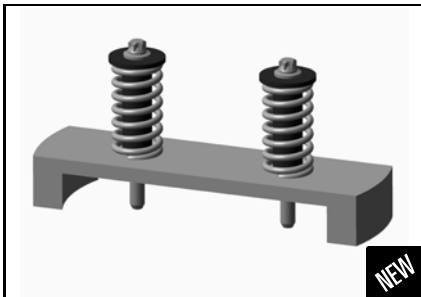

Clutch pack compression tool

P/N 529 036 144

Mandatory

991 SE5
Used for SE5 transmission

Brake



Master cylinder rod adjuster

P/N 529 036 119

Mandatory

Roadster

Steering



Magnet socket
P/N 529 036 178 Recommended
Roadster

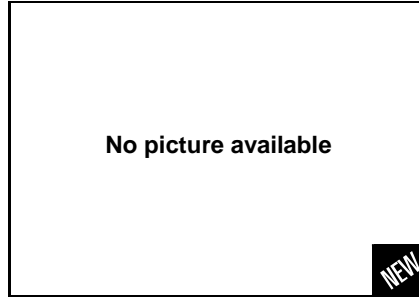

Pitman arm installer
P/N 529 036 225 Recommended
Roadster, ATV



Magnetic lever with laser
P/N magnetic_lazer Recommended
Roadster
JOBMATE or equivalent

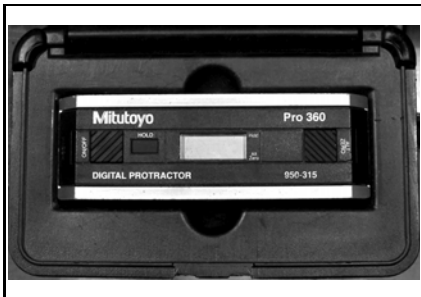

Caster angle protractor
P/N Protractor Dig Recommended
Roadster



Alignment bar
P/N Straight Bar 6' Recommended
Roadster
Use 6 feet aluminum angle bar

Suspension



Shock preload adjustment wrench
P/N 529 032 900 Recommended



Ball joint installer
P/N 529 035 975 Recommended
REV-XP, Roadster



Spring remover
P/N 529 036 007 Recommended
All models
Replace by 529036184

Suspension



Ball joint remover support
P/N 529 036 121 Recommended
REV, ATV, TSS, roadster

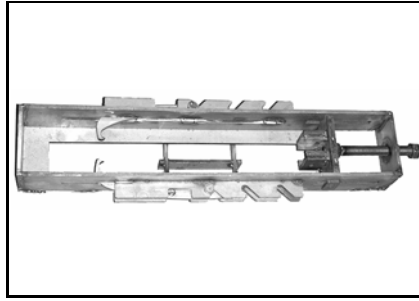

Spring compressor
P/N 529 036 184 Recommended
All models
To remove coil spring from shock.

Various

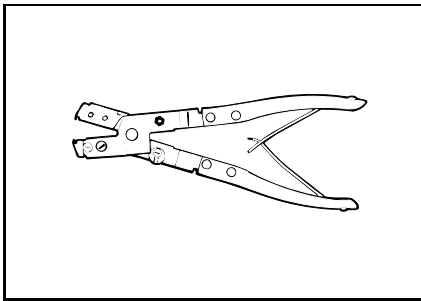

Oetiker pliers
P/N 295 000 069 Recommended
All models

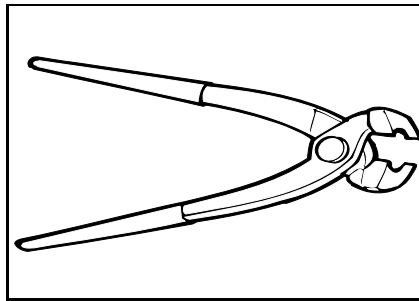

Oetiker pliers
P/N 295 000 070 Recommended
All models

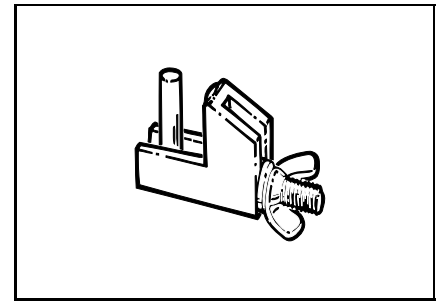

Small hose pincher
P/N 295 000 076 Recommended
All models



Handle
P/N 420 877 650 Recommended
All models
Can be used with many types of pushers.

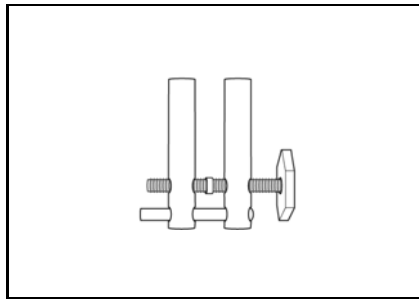

Large hose pincher
P/N 529 032 500 Recommended
All models

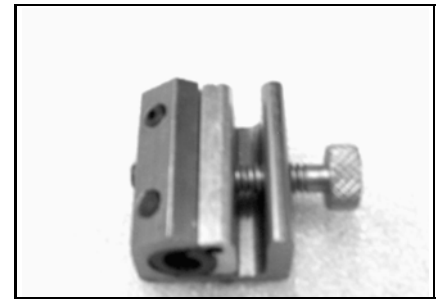

Cable luber
P/N 529 035 738 Recommended
All cables

Various

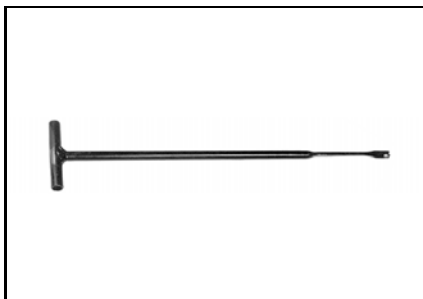

Spring installer/remover

P/N 529 035 983

Recommended

All models



Blind hole bearing puller set

P/N 529 036 117

Recommended

All models

Replaced by 529036056

Index

Tool Part Numbers ... Page

These tools are mandatory

295000069	9	529036124	3
295000070	9	529036133	3
295000076	9	529036142	7
420277010	5	529036144	7
420877650	9	529036166	5
529014500	5	529036174	5
529021800	2	529036175	5
529032500	9	529036178	8
529032900	8	529036181	3
529035652	6	529036184	9
529035661	2	529036223	5
529035687	2	529036225	8
529035697	5	710000851	6
529035709	4	AMP 755430-2	6
529035714	4	carbturne pro	4
529035724	2	magnetic_lazer	8
529035730	5	Motion_Pro	4
529035738	9	Protractor Dig	8
529035868	5	Snap-on RC 980	3
529035880	2	Snap-on TA362	3
529035933	2	Snap-on YA 8230	3
529035975	8	Straight Bar 6'	8
529035983	10		
529035991	4		
529036007	8		
529036018	5		
529036023	4		
529036063	5		
529036069	2		
529036072	2		
529036073	2		
529036074	2		
529036075	2		
529036088	6		
529036089	4		
529036092	2		
529036093	3		
529036094	3		
529036095	6		
529036096	6		
529036097	3		
529036098	3		
529036106	5		
529036113	7		
529036114	3		
529036115	7		
529036117	10		
529036119	7		
529036121	9		
529036123	3		