

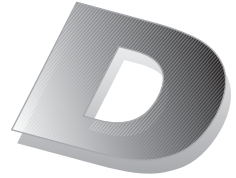

ATV
PREDELIVERY
Bulletin



June 4, 2010

Subject: **Can-Am™ DS 70™ / DS 90™ / DS 90™ X™**
Predelivery Inspection

No.

2011-1

YEAR	MODEL	MODEL NUMBER	SERIAL NUMBER
2011	DS 70	3KBA	All
	DS 90	3CBA / 3CBB	
	DS 90 X	3LBA / 3LBB	

TABLE OF CONTENTS

	Page		Page
IMPORTANT NOTICE	2	Protective Materials	12
UNCRATING	3	ADJUSTMENTS	12
PARTS TO BE INSTALLED	4	General Guidelines	12
Battery	4	Carburetor	12
Front Bumper	5	Drive Chain	12
Front Suspension	6	Transmission Lever	13
Wheels	6	Suspension	14
Handlebar	8	Brakes	15
Front Reflector	9	ASSEMBLY INSPECTION	16
Vehicle Decals	9	FINAL INSPECTION	16
Accessories Installation	9	Vehicle Test Run	16
FLUIDS	9	Vehicle Cleaning	17
Fuel	9	Delivery To Customer	17
Engine Oil	10	TECHNICAL DATA	18
Gearbox Oil	10		
Brake Fluid	11		
SET-UP	12		
Tire Pressure	12		
Brake Discs Cleanup	12		

IMPORTANT NOTICE

This bulletin must be used in conjunction with the check list enclosed in the bag with *OPERATOR'S GUIDE*. Make sure that *PREDELIVERY CHECK LIST* is completed and signed.

WARNING

To obtain warranty coverage, predelivery procedure must be performed by an authorized Bombardier Recreational Products Inc. (BRP) Can-Am™ ATV dealer/distributor. Apply all necessary torques as indicated.

NOTE: Information and components/system descriptions contained in this document are correct at time of publication. BRP however, maintains a policy of continuous improvement of its products without imposing upon itself any obligation to install them on products previously manufactured.

Due to late changes, there might be some differences between manufactured product and descriptions and/or specifications in this document. BRP reserves the right at any time to discontinue or change specifications, designs, features, models or equipment without incurring obligation.

Illustrations in this document show typical construction of different assemblies and may not reproduce full detail or exact shape of parts. However, they represent parts that have same or similar function.

Content of this bulletin is designed as a guideline only. All mechanics performing predelivery procedures should have attended current model-year service training.

Further information or inquiries should be directed to service representative and/or specific *SHOP MANUAL* sections.

Please complete *PREDELIVERY CHECK LIST* for each vehicle and retain a customer-signed copy.

Make sure customer receives *OPERATOR'S GUIDE*, *PREDELIVERY CHECK LIST* signed copy and *SAFETY DVD*.

WARNING

Torque wrench tightening specifications must strictly be adhered to. Locking devices (e.g. lock tabs, elastic nuts) must be installed or replaced by new ones, where specified. Fasteners with locking agent must be replaced by new ones. If the efficiency of a locking device is impaired, it must be renewed.

UNCRATING

NOTICE Allowing the crate to drop may cause serious damage to the vehicle.

NOTICE While manipulating to cut, take care not to damage trim components with blade.

- Carefully lay crate on its bottom.
- Lift off metal corners using a screwdriver.

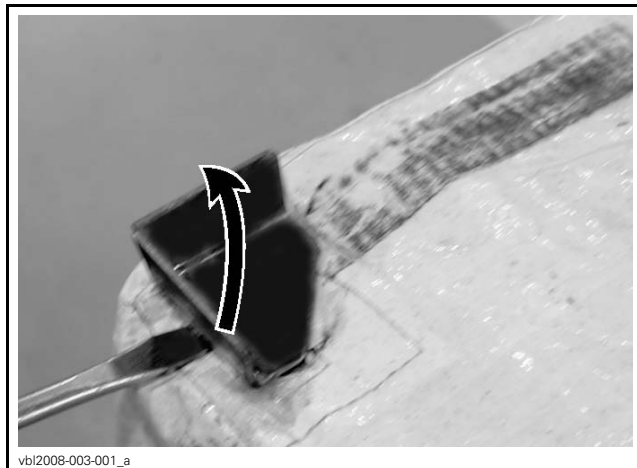

- Remove tarpaulin by lifting it up.

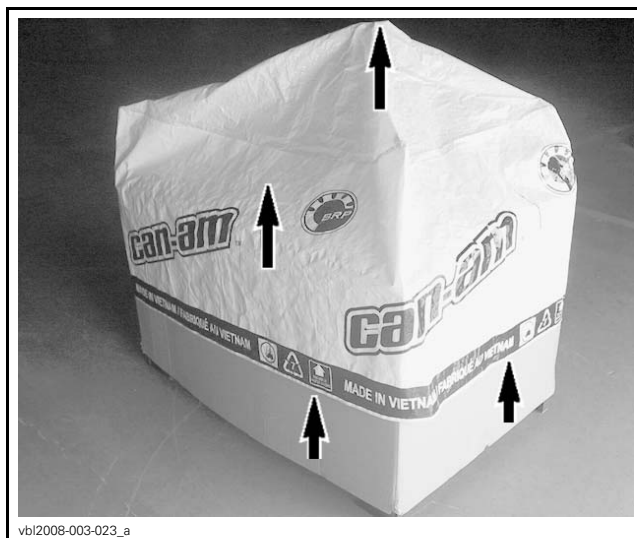

- Remove protective wrapping all over vehicle.
- Remove cardboard box from crate.

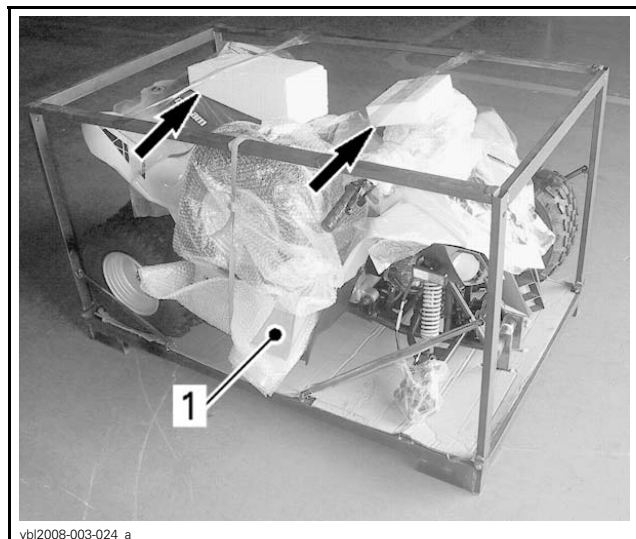

1. Cardboard box

DS 70 and DS 90

- Ensure that the cardboard box includes the following items:

ITEM	DESCRIPTION	QTY
1	Front Bumper (with skid plate assembly)	1
2	M8 x 14 Front Bumper Screw	4
3	M8 Front Bumper Washer	4
4	Battery	1
5	Battery Bracket	1
6	M6 x 12 Battery Screw	2
7	Left Front Reflector	1
8	M6 Reflector Nut	1
9	Wheel Hub Caps	4

DS 90 X

- Ensure that the cardboard and the front storage compartment include the following items:

PARTS TO BE INSTALLED

ITEM	DESCRIPTION	QTY
1	Battery	1
2	Battery Bracket	1
3	M6 x 12 Battery Screw	2
4	Left Front Reflector	1
5	M6 Reflector Nut	1
6	M10 x 40 Suspension Lower Bolt	2
7	M10 Suspension Lower Nut	2
8	Handlebar Upper Support	2
	Handlebar Retaining Screw	4
9	Handlebar Foam	1
10	Handlebar Cover	1
11	Wheel Hub Caps	4

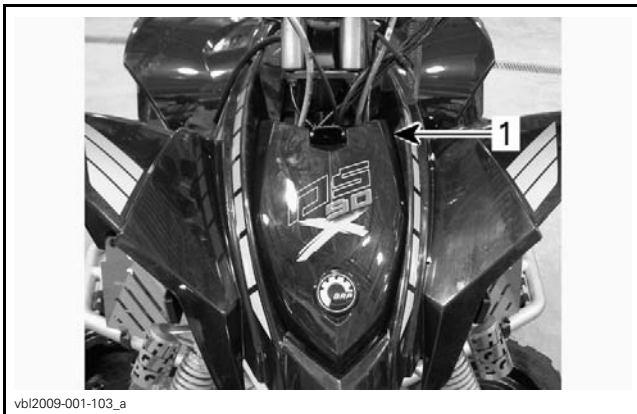

1. Front storage compartment

8. Lift up and remove upper longitudinal flat bar.
9. Cut straps holding front wheels assembly to crate frame.
10. Cut cotter pins retaining bottom angle bars on end frame.
11. Bring angle bars down.

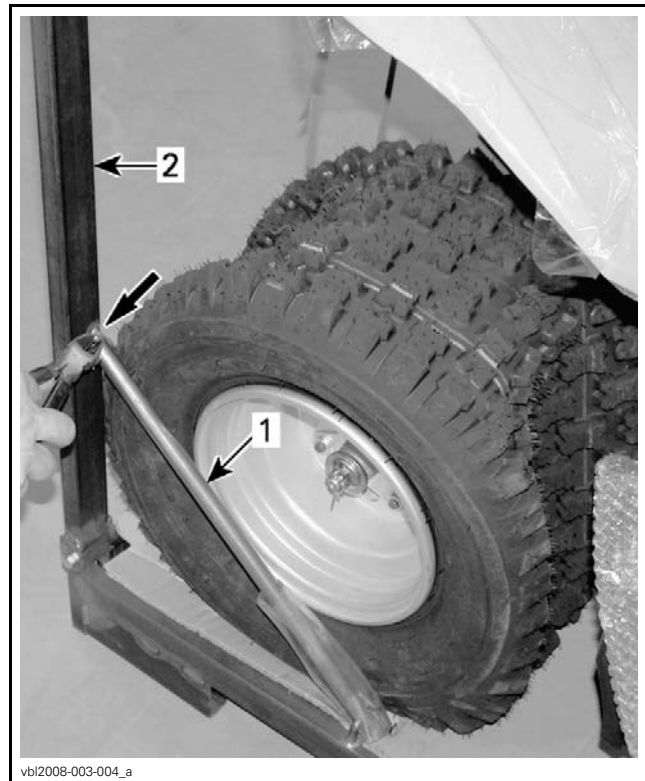

1. Bottom angle bar
2. End frame

12. Lower front and rear end frames down.

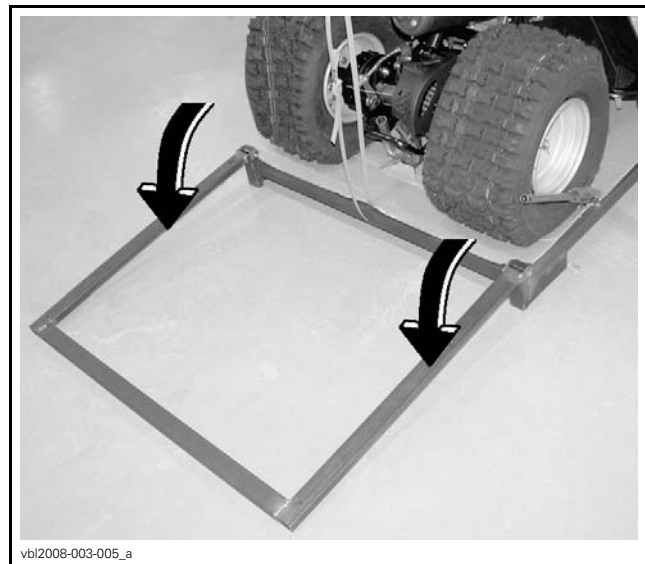

MOVE END FRAME DOWN

PARTS TO BE INSTALLED

Battery

1. Refer to the latest edition of *CAN-AM ATV BATTERIES SERVICE BULLETIN* for proper activating, charging and maintenance procedures.

NOTICE Always charge battery before its installation on the vehicle.

- Remove seat by moving release lever.

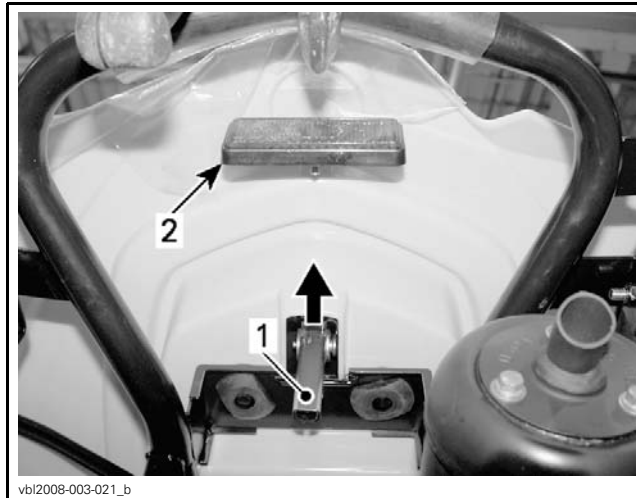

- Release lever
- Tail reflector

- Install charged battery on vehicle.

CAUTION Never charge or boost battery while installed on vehicle.

- Secure battery in place using supplied bracket with its M6 x 12 screws.

NOTICE Make sure not to squeeze battery cables between vehicle components.

- Apply DIELECTRIC GREASE (P/N 293 550 004) on battery posts.
- Connect RED positive cable to positive battery post.
- Connect BLACK negative cable to negative battery post.

NOTICE Always connect RED positive cable first and then BLACK negative cable.

- Cover positive post with rubber boot.

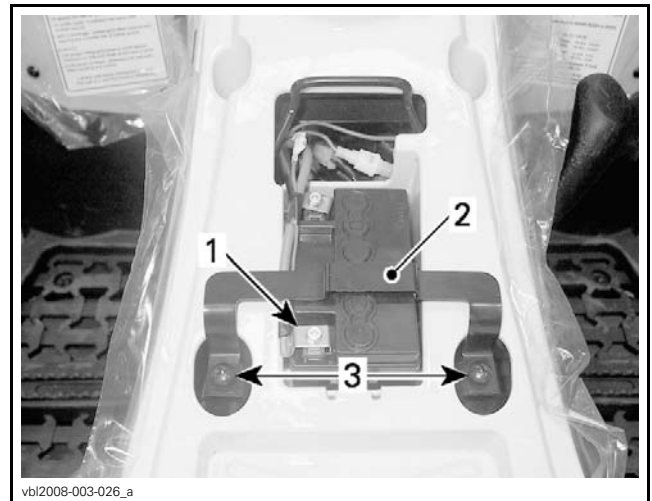

- RED positive post
- Bracket
- M6 x 12 screws

- Reinstall seat.

Front Bumper

DS 70 and DS 90

- Lift front of vehicle.
- Slide a wooden box underneath to keep front of vehicle raised.

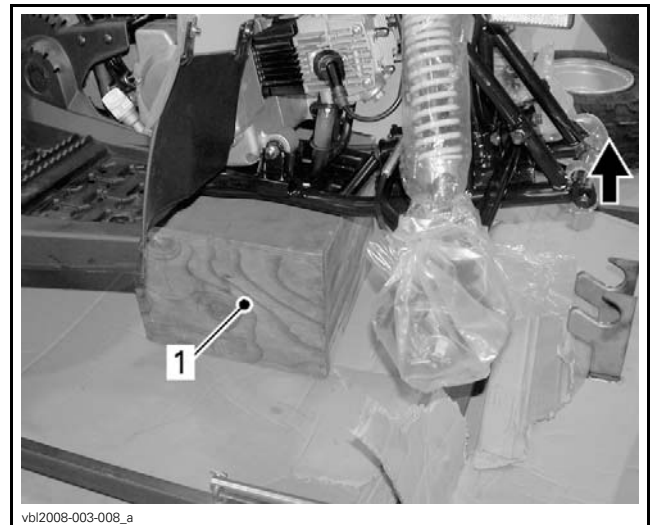

- Wooden box

- Align front bumper (with skid plate assembly) in place.
- Secure to frame with M8 x 14 screws and M8 washers.
- Torque screws to 23 N•m (17 lbf•ft).

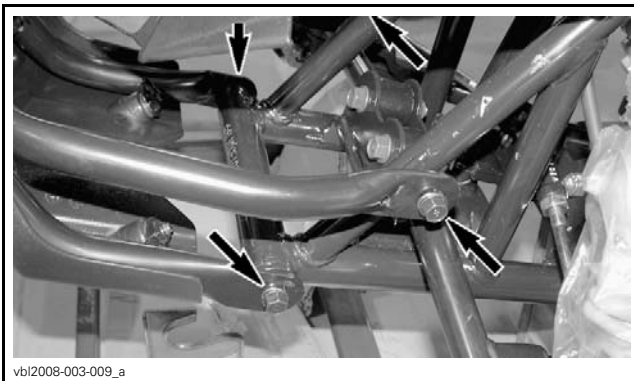

vbi2008-003-009_a

FRONT BUMPER SCREWS

DS 90 X

6. Confirm that all bumper fasteners are properly tightened.

Front Suspension

DS 90 X

1. Install front suspensions on suspension arms using M10 bolts and M10 nuts.
2. Torque front suspension lower nuts to 40 N•m (30 lbf•ft).

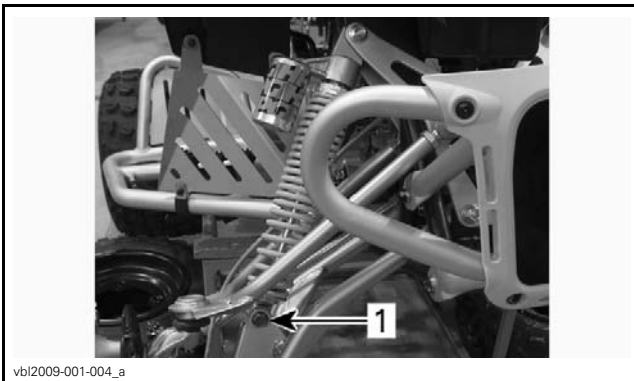

vbi2009-001-004_a

1. Front suspension lower bolt

Wheels

Front wheels

NOTE: Front wheel hub nuts with flat washers and cotter pins are shipped on hubs.

1. Protect front bumper with a clean rag.
2. Hook up and lift front of vehicle.
3. Remove wooden box from underneath.

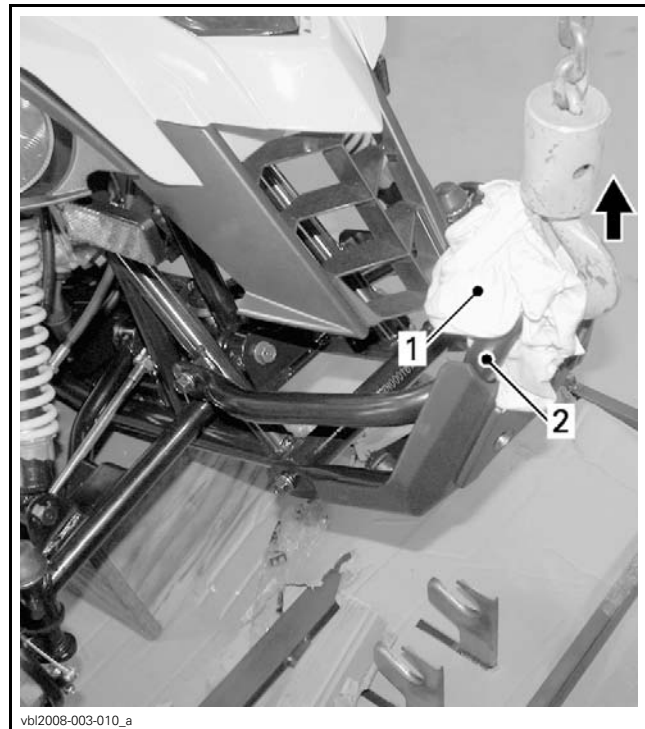

vbi2008-003-010_a

1. Protection
2. Front bumper

4. Inflate tires to specified air pressure.

⚠ WARNING

Low pressure may cause tire to deflate and rotate on wheel. Overpressure may burst tire. Always follow recommended pressure. Since tires are low-pressure type, a manual pump should be used.

NOTICE Always check pressure when tires are cold.

FRONT TIRE PRESSURE	
MAXIMUM	35 kPa (5 PSI)
MINIMUM	25 kPa (3.5 PSI)

5. Make sure back plate with linings assembly is properly indented in place on both sides.

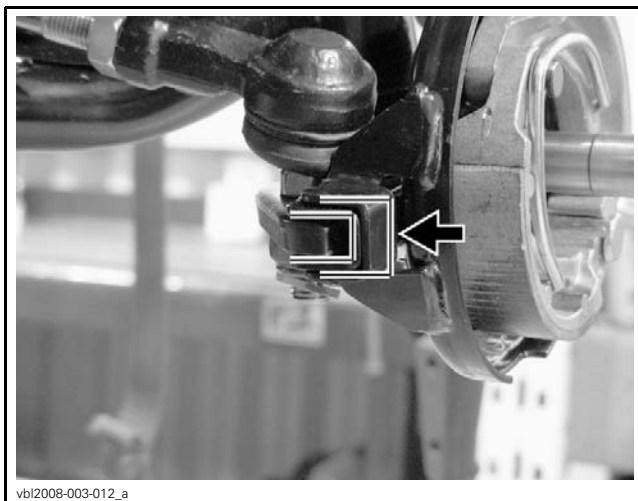

vbl2008-003-012_a

TYPICAL DS 70 AND DS 90

6. Install front wheels on vehicle.
7. Install bushing on the outside.
8. Ensure that the rotation direction shown by the arrow is respected.

NOTICE Respect the rotation direction shown by the arrow on the outside wall of the tire.



vbl2008-003-025_a

9. Torque wheel hub nuts to 75 N•m (55 lbf•ft).
10. Tighten further until one of wheel hub grooves is aligned with a cotter pin hole.
11. Secure nuts in place using supplied cotter pins.

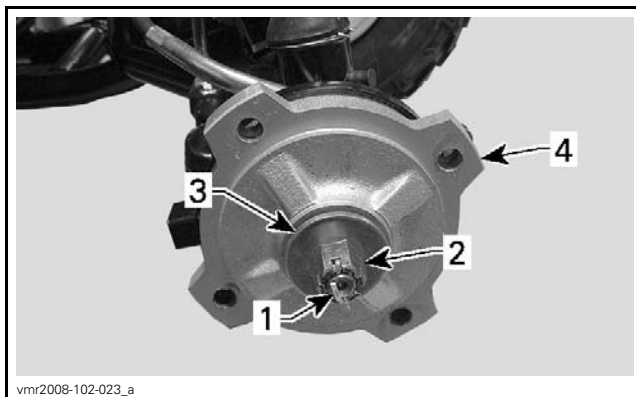

vmr2008-102-023_a

TYPICAL DS 70 AND DS 90

1. Cotter pin
2. Wheel hub nut
3. Washer
4. Wheel hub

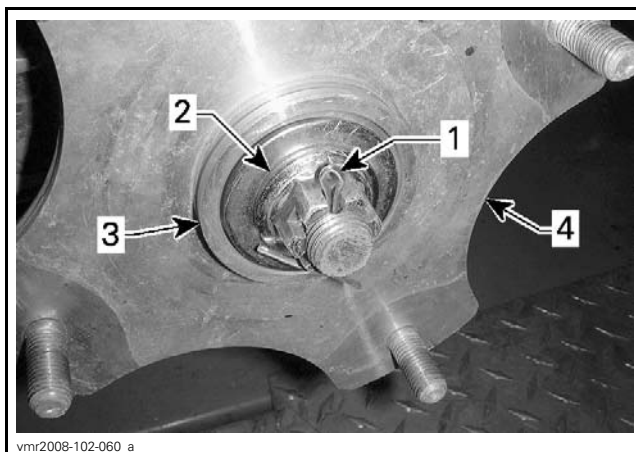

vmr2008-102-060_a

TYPICAL DS 90 X

1. Cotter pin
2. Wheel hub nut
3. Washer
4. Wheel hub

12. Install wheel hub caps.
13. Lower front of vehicle back on the ground.
14. Ensure that wheel lug nuts are tightened to 40 N•m (30 lbf•ft).

Rear Wheels

NOTICE Rear wheels are installed wrong side out for shipping purpose.

1. Cut strap holding rear of vehicle to crate.
2. Carefully lift rear of vehicle.
3. Remove both rear wheels.
4. Inflate tires to specified air pressure.

REAR TIRE PRESSURE	
MAXIMUM	35 kPa (5 PSI)
MINIMUM	25 kPa (3.5 PSI)

5. Install wheels good side out.
6. Tighten RH wheel hub nut just enough to install the cotter pin.
7. Secure RH nut in place using cotter pin.
8. Torque LH wheel hub nut to 122 N•m (90 lbf•ft).

NOTICE Ensure that the rear axle is centered on the vehicle while tightening the wheel hub nuts.

9. Tighten LH wheel hub nut further until one of wheel hub grooves is aligned with a cotter pin hole.
10. Secure LH nut in place using cotter pin.

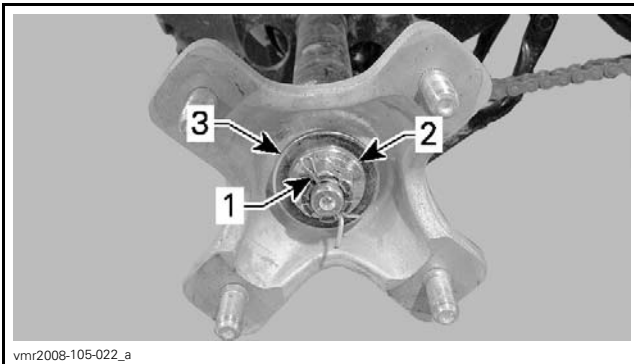

TYPICAL
 1. Cotter pin
 2. Wheel hub nut
 3. Washer

11. Install wheel hub caps.
12. Lower rear of vehicle back on the ground.
13. Ensure that wheel lug nuts are tightened to 40 N•m (30 lbf•ft).
14. Cut locking tie holding protective shield around axle.
15. Remove protective shield from vehicle.

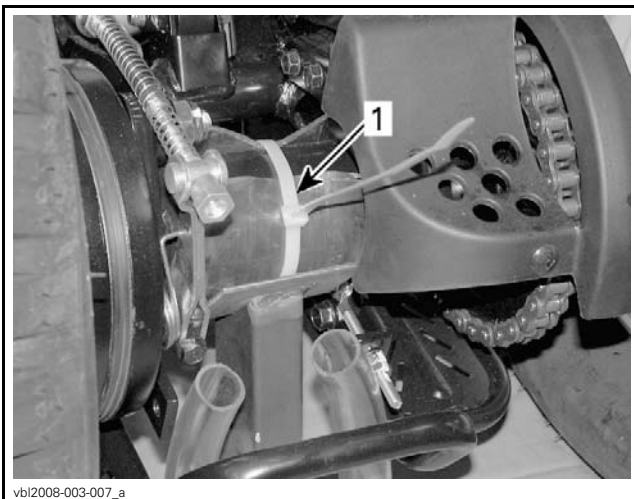

1. Locking tie

Handlebar

DS 70 and DS 90

1. Remove center handlebar cap.
2. Remove handlebar bracket.

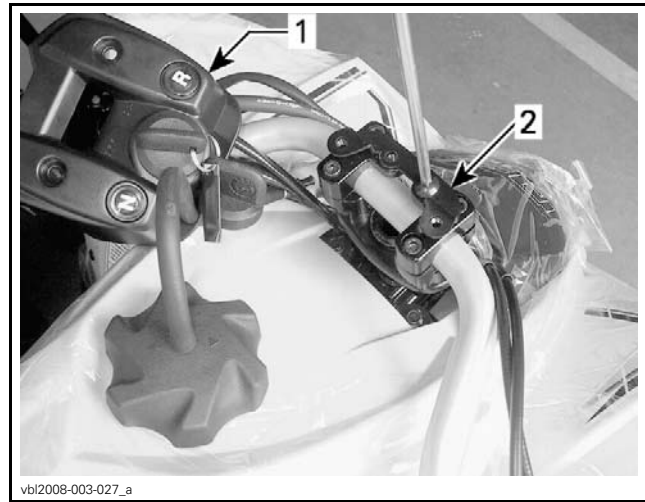

1. Center handlebar cap
 2. Handlebar bracket

3. Loosen handlebar retaining screws.
4. Adjust handlebar so that both brake fluid reservoirs are level.

⚠ WARNING
 Make sure cables, wires and hoses are not squeezed between the handlebar and vehicle components.

5. Torque handlebar retaining screws to 9 N•m (80 lbf•in) in a crisscross sequence.
6. Install handlebar bracket.
7. Install center cap.

⚠ WARNING
 Turn handlebar completely from one side to the other making sure it does not exert a unwanted tension on throttle cable, brake hose, and other wires.

DS 90 X

1. Install handlebar on lower supports.

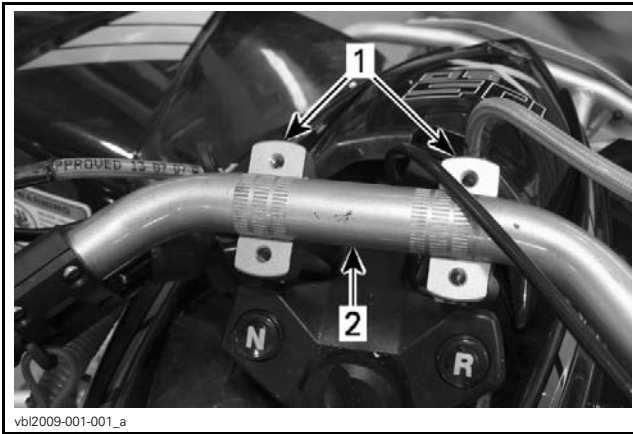

1. Lower supports
2. Handlebar

2. Install upper supports on handlebar.
3. Adjust handlebar so that both brake fluid reservoirs are level.
4. Torque handlebar retaining screws to 9N•m (80 lbf•in) in a crisscross sequence.

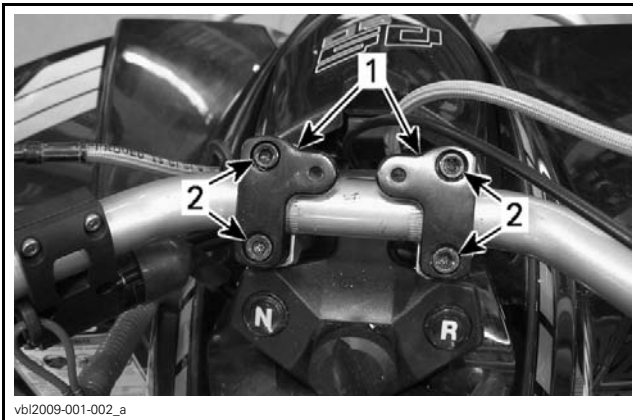

1. Upper supports
2. Handlebar retaining screws

5. Install handlebar foam.
6. Install handlebar cover.



1. Handlebar cover

⚠ WARNING

Turn handlebar completely from one side to the other making sure it does not exert a unwanted tension on throttle cable, brake hose, and other wires.

Front Reflector

1. Install left side reflector at front of vehicle.
2. Secure with M6 nut.

Vehicle Decals

1. Install decals on vehicle according to customer country language and local legislation.
2. Ensure that the new decals are installed at the same location and over the factory installed decals.

Accessories Installation

1. Install accessories (if any) as per their installation instructions (included in each kit).
2. Install any other equipment required by local legislation (if any).

FLUIDS

All fluids (except fuel) have already been filled at factory, it is only necessary to validate them. However, if refill is needed, refer to the appropriate *ATV SHOP MANUAL* for the proper procedure.

Fuel

1. Add fuel in the fuel reservoir.
2. Turn on fuel valve.



FUEL VALVE

Recommended fuel

NOTE: Use regular unleaded gasoline or gasohol containing less than 10% ethanol or methanol, available from most service stations.

Refer to the following table for recommended minimum octane rating :

COUNTRY	OCTANE RATING
North America	87 (RON + MON) / 2
Elsewhere	91 RON

⚠ WARNING

Always stop engine before refueling. Open cap slowly. If a differential pressure condition is noticed (whistling sound heard when loosening fuel tank cap) have vehicle inspected and/or repaired before further operation. Fuel is flammable and explosive under certain conditions. Never use an open flame to check fuel level. Never smoke or allow flame or spark in vicinity. Always work in a well-ventilated area. Never top up the fuel tank before placing the vehicle in a warm area. As temperature increases, fuel expands and may overflow. Always wipe off any fuel or oil spillage from the vehicle.

NOTICE Never place anything over fuel tank cap as this could block the vent hole, leading to engine misfire.

NOTICE Never experiment with other fuels. The use of not recommended fuel can result in vehicle performance deterioration and damage to critical parts in fuel system and engine components.

NOTICE Never mix oil with fuel.

Engine Oil

NOTICE Do not overfill. Operating the engine with an improper oil level may severely damage the engine. Wipe off any oil spillage.

Recommended Engine Oil

For the summer season, use XPS SYNTHETIC BLEND OIL (SUMMER GRADE) (P/N 293 600 121).

For the winter season, use XPS SYNTHETIC OIL (WINTER GRADE) (P/N 293 600 112).

NOTE: The XPS oil is specially formulated and tested for the severe requirements of this engine.

Engine Oil Level Verification

1. Ensure that engine is cold and not running.
2. Park vehicle straight on a level surface.
3. Unscrew and remove oil dipstick.

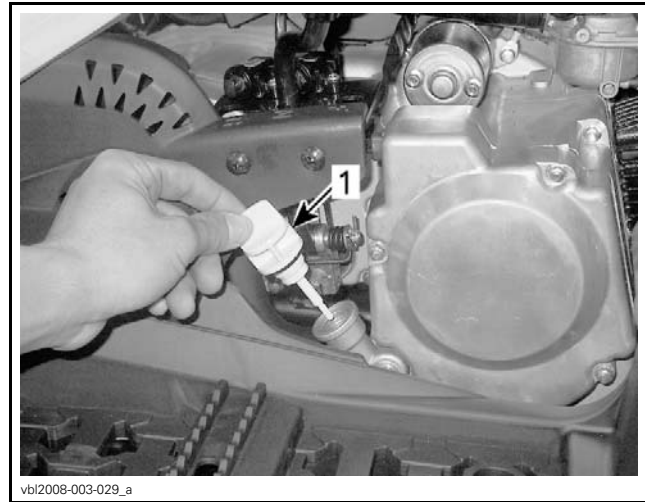

1. Engine oil dipstick

4. Wipe oil dipstick.
5. Reinstall dipstick (do not screw it in).
6. Remove dipstick.
7. Check oil level as per the following illustration.



UPPER MARK (FULL)

8. Ensure that oil level is close to or on upper mark (Full).
9. If necessary, add recommended engine oil.
10. Reinstall and screw in dipstick completely.

Gearbox Oil

Recommended Gearbox Oil

Use XPS CHAINCASE OIL (P/N 415 129 500).

NOTICE Do not use non recommended types of oil when servicing. Do not mix with other types of oil.

Gearbox Oil Level Verification

NOTICE Make sure to use a clean (completely free of greasy matter) wire to avoid oil contamination.

NOTE: The following procedure is not an accurate one, it must be only used to verify the presence of oil in the gearbox. If necessary, refer to the appropriate *ATV SHOP MANUAL* for complete procedure.

1. Ensure that engine is cold and not running.
2. Park vehicle straight on a level surface.
3. Loosen carburetor boot clamp.

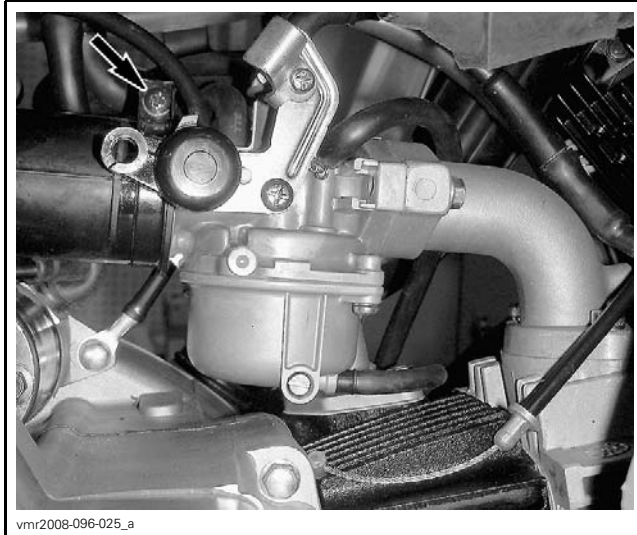

CARBURETOR BOOT CLAMP SCREW

4. Remove air filter housing retaining screws.

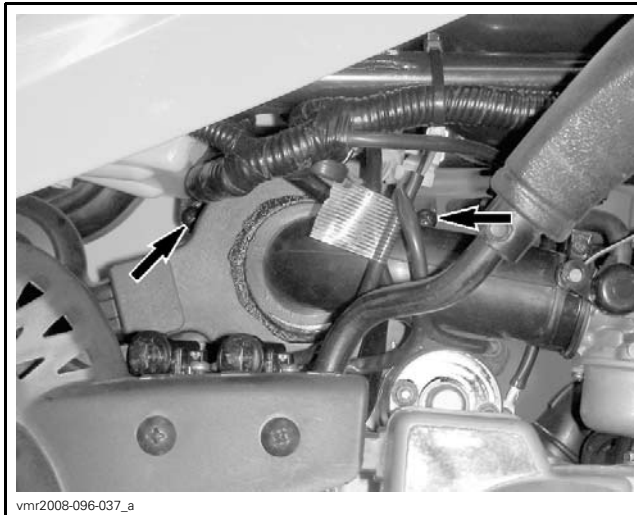

AIR FILTER HOUSING RETAINING SCREWS

5. Remove air filter housing from vehicle.
6. Remove gearbox oil filler plug.



1. Gearbox oil filler plug

7. Get a piece of 16-18 gauge clean wire, 203 mm to 305 mm (8 in to 12 in) long.
8. Insert approximately 133 mm (5-1/4 in) into the filler hole.
9. Pull wire out the filler hole.
10. Check gearbox oil level as per the following illustration.

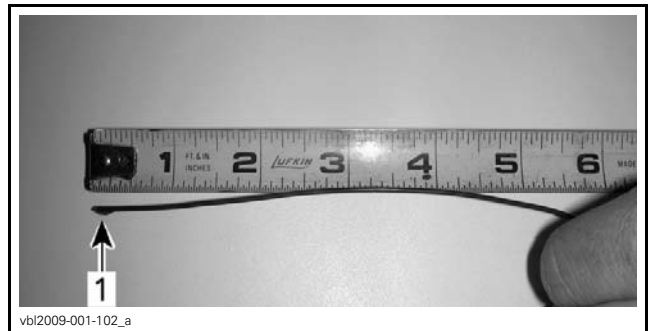

1. Gearbox oil

11. Ensure there approximately 6 mm (1/4 in) of oil on the wire.
12. Reinstall and screw in filler plug completely.
13. Reinstall air filter housing on vehicle.

Brake Fluid

DS 90 X Only

Recommended Brake Fluid

Use BRAKE FLUID (DOT 4) (P/N 293 600 131).

NOTICE Use DOT 4 brake fluid from a sealed container only.

Brake Fluid Level Verification

1. Park vehicle straight on a level surface.
2. Place steering in the straight ahead position.
3. Locate front brake fluid reservoir on the right side of handlebar.

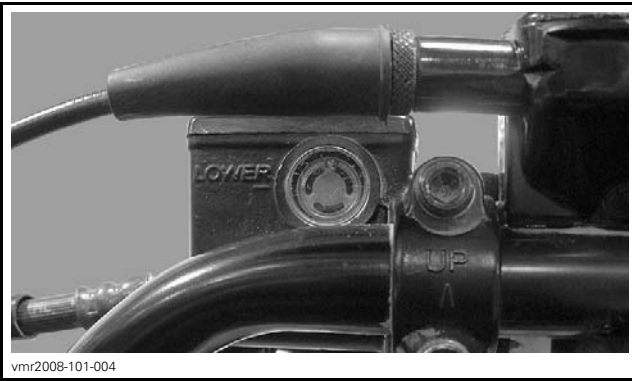

vmo2008-101-004

RH FRONT BRAKE FLUID RESERVOIR

4. Check brake fluid through the window.

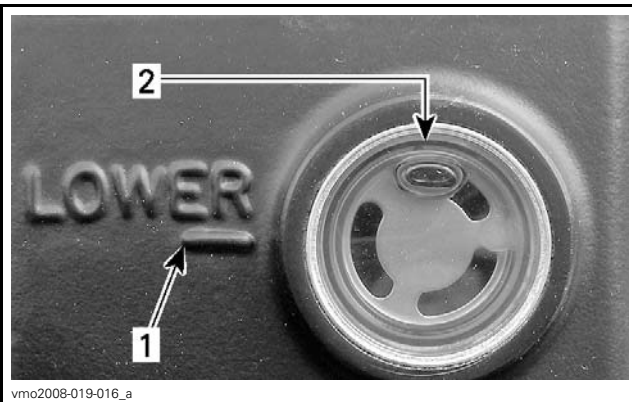

vmo2008-101-016_a

1. MIN. mark
2. MAX. mark

5. Ensure fluid reaches top of the window.
6. If necessary, add recommended brake fluid.
7. Locate rear brake fluid reservoir on the left side of handlebar.



vmo2008-101-003

LH REAR BRAKE FLUID RESERVOIR

8. Check brake fluid through the window.
9. Ensure fluid reaches top of the window.
10. If necessary, add recommended brake fluid.

SET-UP

Tire Pressure

1. Ensure that tires are inflated to the specified air pressure. Refer to *WHEELS*.

Brake Discs Cleanup

DS 90 X Only

1. Clean front and rear brake discs using PULLEY FLANGE CLEANER (P/N 413 711 809).

NOTICE A thin layer of anticorrosion product can be present on the brake disc and must be removed before using the vehicle. Not conforming to this procedure may lead to a brake chattering and the brake pads replacement would be necessary to solve the problem.

Protective Materials

1. Ensure that all protective materials are removed from vehicle.

ADJUSTMENTS

General Guidelines

All adjustments have already been performed at factory, it is only necessary to validate them. However, if readjustment is needed, refer to the appropriate *ATV SHOP MANUAL* for the proper detail procedure.

Carburetor

Inspect the following items and adjust if required:

- Idle speed
- Throttle cable
- Choke cable.

Drive Chain

⚠ WARNING

Place ignition switch to OFF before checking, adjusting or lubricating the drive chain.

NOTICE Never operate this vehicle with the drive chain too loose or too tight as severe damage to the drive components can occur.

1. Verify drive chain for damaged links and rollers.
2. Lubricate drive chain using commercial chain lubricant.

- Check that drive chain deflection is properly adjusted.

DRIVE CHAIN DEFLECTION	
DS 70 / DS 90 / DS 90 X	44 mm to 57 mm (1-3/4 in to 2-1/4 in)

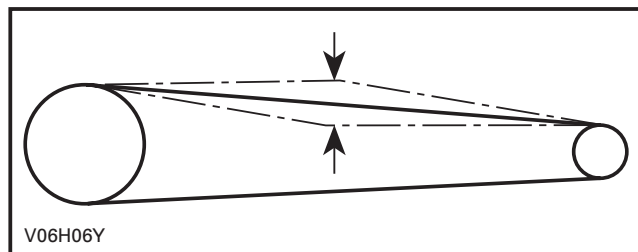

CHAIN DEFLECTION

- If necessary, adjust drive chain deflection. Refer to *DRIVE CHAIN ADJUSTMENT*.

Drive Chain Adjustment

NOTE: Never adjust drive chain with the driver seated on the vehicle. Remove all load on the vehicle.

- Park vehicle straight on a level surface.
- Set transmission lever to NEUTRAL.
- Loosen rear axle locking bolts.

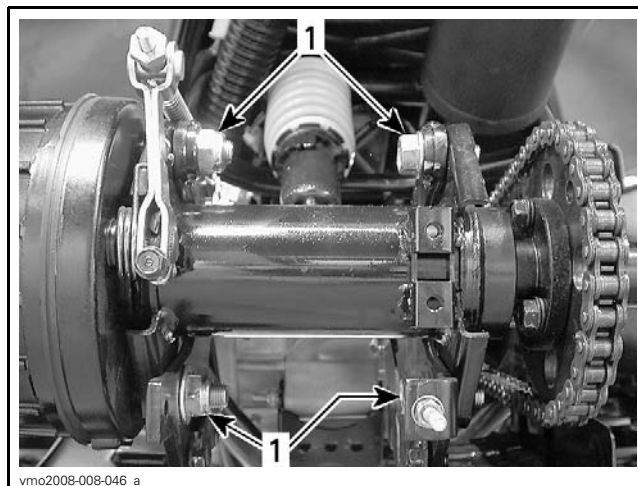

TYPICAL - REAR AXLE
1. Locking bolts

- Loosen chain adjuster lock nut.

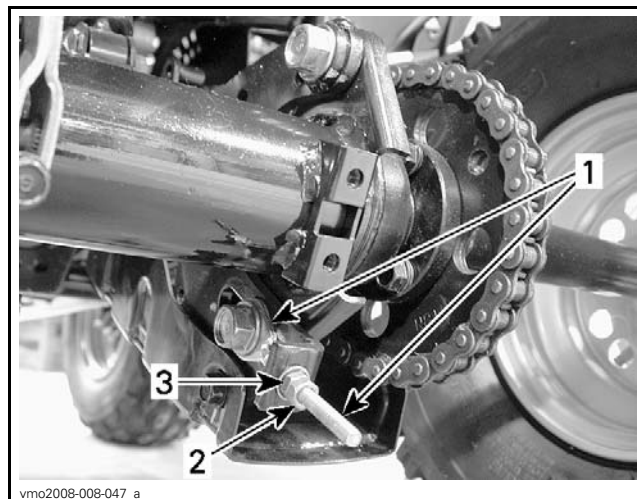

TYPICAL

- Chain adjuster
- Chain adjuster lock nut
- Chain adjuster nut

- On so equipped models, push and hold chain tensioner to release chain tension.

NOTE: An automatic chain tensioner (P/N V72301DGF000) is available for DS 70 and DS 90 series. This device has been designed to reduce the chain tension adjustment frequency and drive chain maintenance.

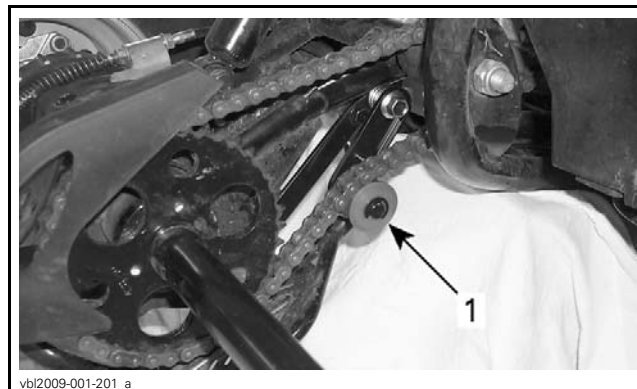

1. Chain tensioner

- Turn chain adjuster nut until proper adjustment is obtained. Refer to *DRIVE CHAIN DEFLECTION* table.
- Tighten chain adjuster lock nut.
- Tighten rear axle locking bolts to 69 N•m (51 lbf•ft).

NOTE: When the adjustment is done, repeat the above procedure to check the deflection several times at different spots on the chain.

Transmission Lever

- Verify that transmission lever works properly and adjust if required.

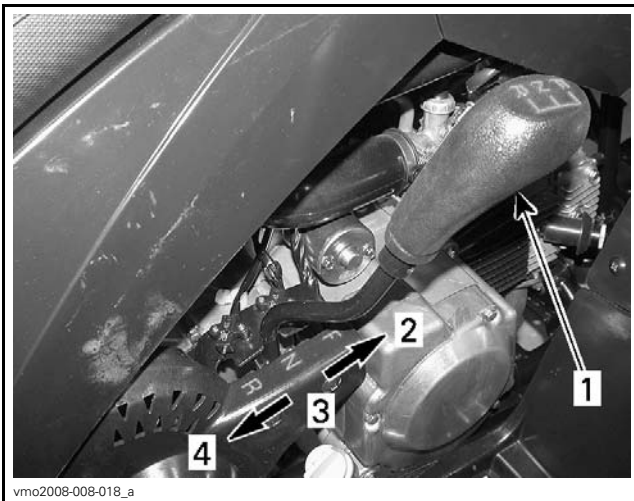

- 1. Transmission lever
- 2. Forward (F)
- 3. Neutral (N)
- 4. Reverse (R)

Suspension

⚠ WARNING

Left and right front shock adjustment must always be set at the same position. Never adjust one shock only. Uneven adjustment can cause poor handling and loss of stability, which could lead to an accident.

Front Suspension

1. Adjust the spring preload as per the owner's preference.
2. Refer to the following table for proper adjustment.

ACTION	SPRING LENGTH	RIDE TYPE	ROAD CONDITION
Turn adjusting cam or rings clockwise	Shorten the spring	Firmer ride	Rough road condition
Turn adjusting cam or rings counterclockwise	Lengthen the spring	Softer ride	Smooth road condition

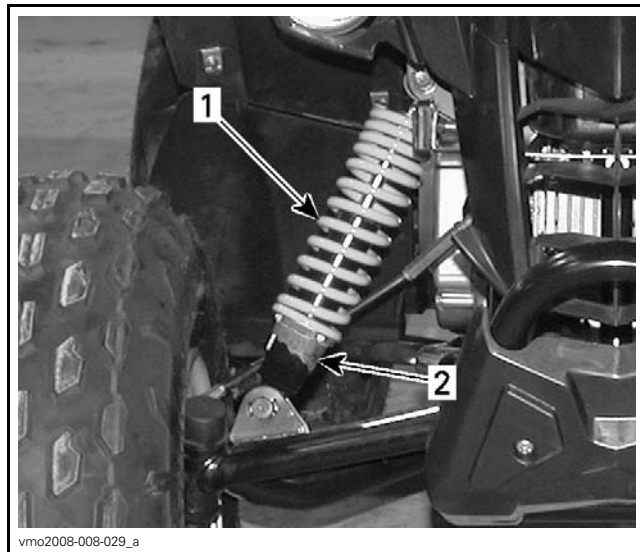

DS 70 AND DS 90 FRONT SUSPENSION
 1. Front spring
 2. Adjusting cam

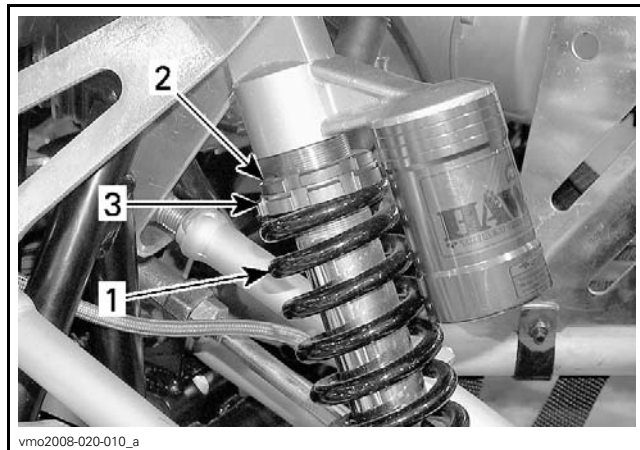

DS90 X FRONT SUSPENSION
 1. Front spring
 2. Locking ring
 3. Adjustment ring

Rear Suspension

1. Adjust the spring preload as per the owner's preference.
2. Refer to the following table for proper adjustment.

ACTION	SPRING LENGTH	RIDE TYPE	ROAD CONDITION
Turn adjusting cam or rings clockwise	Shorten the spring	Firmer ride	Rough road condition
Turn adjusting cam or rings counterclockwise	Lengthen the spring	Softer ride	Smooth road condition

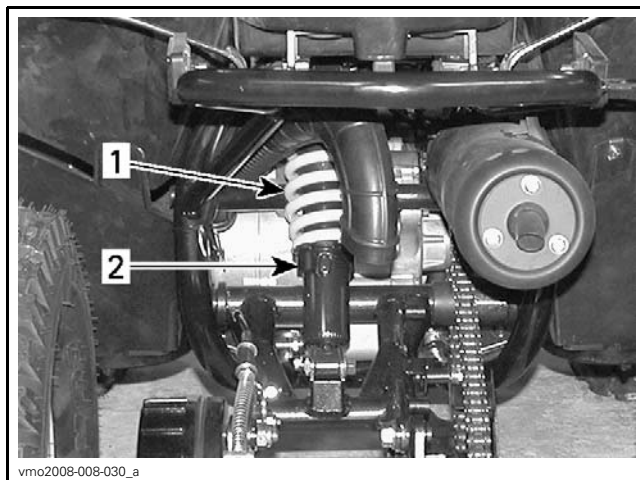

DS 70 AND DS 90 REAR SUSPENSION

1. Rear spring
2. Adjusting cam

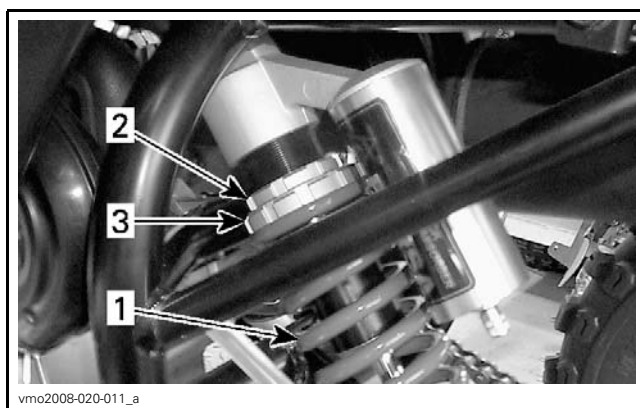

DS 90 X REAR SUSPENSION

1. Rear spring
2. Locking ring
3. Adjustment ring

Brakes

Front Brake

DS 70 and DS 90

1. Check that front brake cables free-play is properly adjusted.

FRONT BRAKE CABLE ADJUSTMENT	
Free-play	10 mm to 12 mm (13/32 in to 1/2 in)

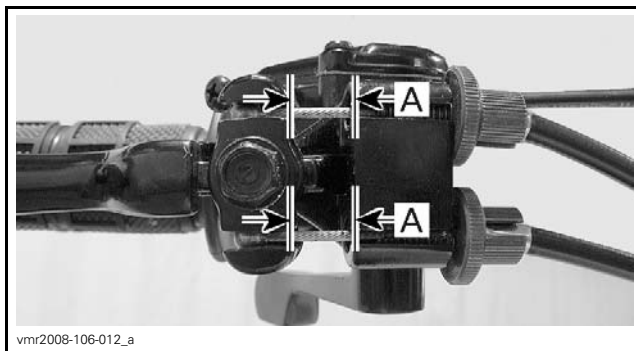

CABLE FREE-PLAY

A. 10 mm to 12 mm (13/32 in to 1/2 in)

2. If necessary, adjust front brake cables using adjusting screws.

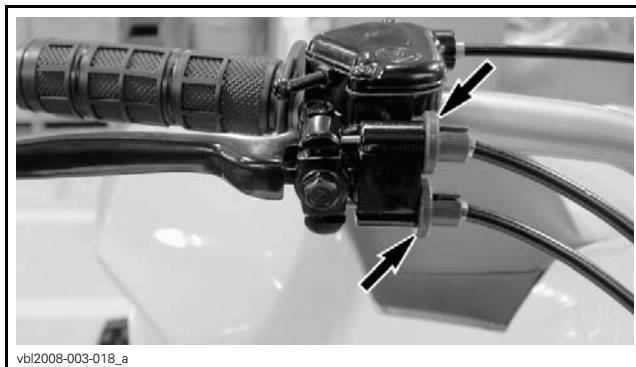

FRONT BRAKE LEVER ADJUSTING SCREWS

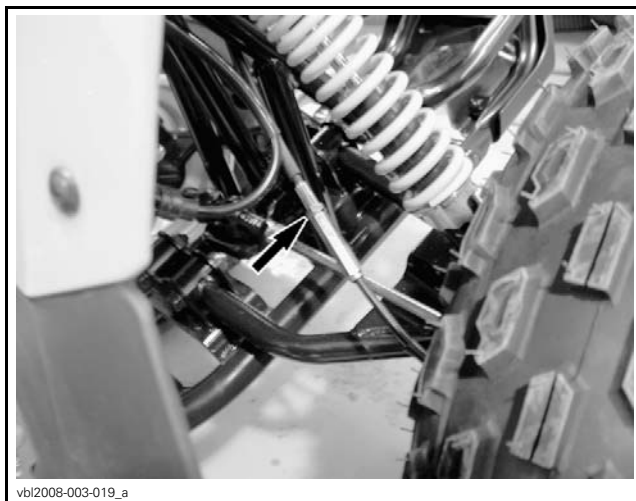

FRONT BRAKE CABLES ADJUSTING SCREWS

3. Ensure that front brakes work properly.

DS 90 X

1. Check that brake lever is not spongy.
2. Ensure that front brakes work properly.

Rear Brake

1. Check that rear brake cable free-play is properly adjusted.

REAR BRAKE CABLE ADJUSTMENT	
Free-play	15 mm to 25 mm (.6 in to 1 in)

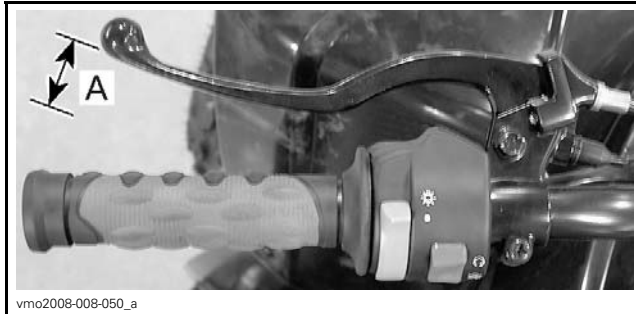

CABLE FREE-PLAY
A. 15 mm to 25 mm (.6 in to 1 in)

- If necessary, adjust rear brake cable using cable adjuster.

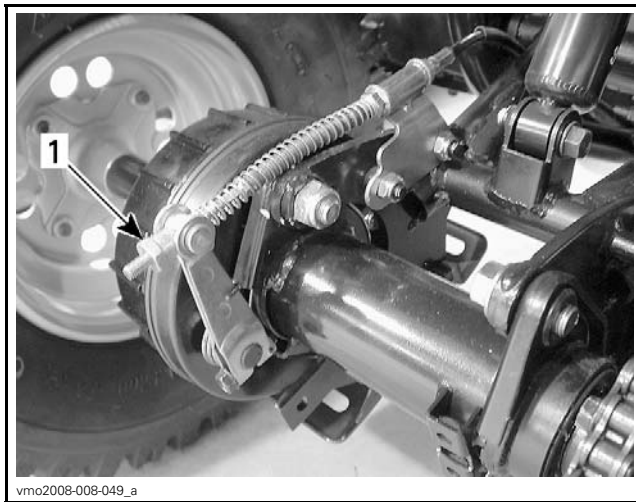

1. Rear brake cable adjuster

- Ensure that rear brake works properly.

DS 90 X

- Check that brake lever is not spongy.
- Ensure that rear brake works properly.

Parking Brake

- Check that parking brake works properly.
 - Apply parking brake lever.
 - Try pushing vehicle forward and rearward.
 - If vehicle moves, readjust.

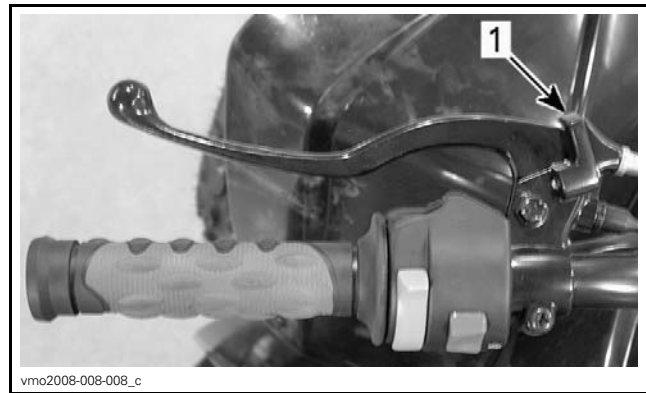

DS 70 AND DS 90 LH BRAKE LEVER
1. Parking brake mechanism

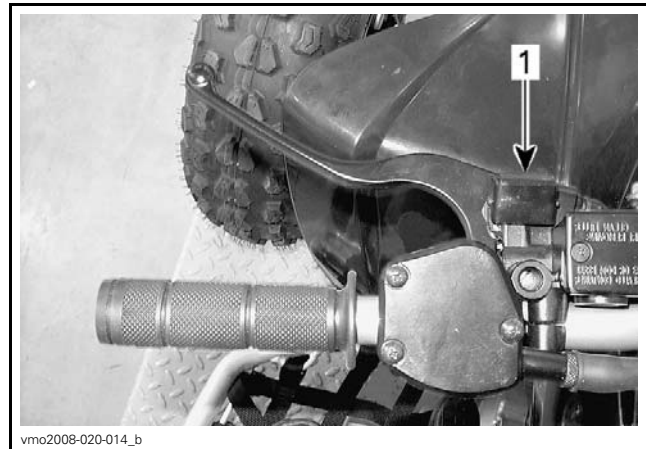

DS 90 X LH BRAKE LEVER
1. Parking brake mechanism

ASSEMBLY INSPECTION

Inspect the following parts to make sure that the vehicle is properly assembled.

- Handlebar tightness
- Wheel nut torque
- Drive chain lubrication
- Tubes/hoses routing and condition
- Steering column cotter pin
- Tie rod end nuts and cotter pins
- Wheel nuts and cotter pins
- Complete applicable recall or factory-directed modification.

FINAL INSPECTION

Vehicle Test Run

Ride the vehicle to ensure proper operation of all systems and components.

Vehicle Cleaning

NOTICE Never use a high pressure washer to clean vehicle, use LOW PRESSURE ONLY (like a garden hose). The high pressure can cause electrical or mechanical damages.

NOTICE It is necessary to use flannel clothes or Kimtowel[†] wipes on plastic parts to avoid damaging surfaces. Never clean plastic parts with strong detergent, de greasing agent, paint thinner, acetone, products containing chlorine, etc.

1. Wash and dry vehicle.
2. Remove any dirt and dust.
3. Clean vinyl and/or plastic parts, using flannel clothes with (P/N 413 711 200).
4. Clean the entire vehicle, including metallic parts, with BRP HEAVY DUTY CLEANER (P/N 293 110 001).

Delivery To Customer

1. Complete the *PREDELIVERY CHECK LIST*.
2. Give *OPERATOR'S GUIDE* and *SAFETY DVD* to customer.

NOTE: The customer must read and sign the *PRE-DELIVERY CHECK LIST*.

NOTE: Hang tag is to be removed by the owner only.

NOTE: Any person who rides this vehicle should read and understand all the information given on hang tag and safety labels before riding.

[†] Kimtowel is a trademark of Kimberly-Clark.

TECHNICAL DATA

MODEL		DS 70	DS 90/DS 90 X
ENGINE			
Type		4-stroke, forced air cooled	
Number of cylinder		Single horizontal cylinder	
Displacement		69.36 cm ³ (4.2 in ³)	89.53 cm ³ (5.5 in ³)
Starting		Electric/kick start	
Engine oil	Type	For the summer season, use XPS SYNTHETIC BLEND OIL (SUMMER GRADE) (P/N 293 600 121). For the winter season, use XPS SYNTHETIC OIL (WINTER GRADE) (P/N 293 600 112)	
	Capacity	Oil change with filter: 1.1 L (1.2 qt (U.S. liq.))	
TRANSMISSION			
Transmission		Continuously Variable Transmission (CVT)	
GEARBOX			
Type		3 positions: Forward, Neutral and Reverse	
Gearbox oil	Type	XPS CHAINCASE OIL (P/N 415 129 500)	
	Capacity	165 ml (6 U.S. oz)	
FUEL SYSTEM			
Carburetor	Make	KEHIN with manual choke	
	Type	PTE	
Idle speed		1700 ± 100 RPM	
Fuel	Type	Unleaded gasoline	
	Octane	Inside North America	87 ((R + M)/2) or higher
		Outside North America	92 RON
Fuel tank	Capacity	6 L (1.6 U.S. gal.)	
ELECTRICAL			
Ignition type		CDI (Capacitor Discharge Ignition)	
Spark plug	Make	NGK	
	Type	CR7HSA	
	Gap	0.6 mm to 0.7 mm (.024 in to .028 in)	
Number of spark plug		1	
Battery	Type	Maintenance free	
	Volt	12 volts, 4 A•h	
Starting system		Electric start/kick start	
Daytime running light bulb		2 x 5 W	
Taillight bulb		N.A.	
Fuse	Main	15 A	

MODEL		DS 70	DS 90/DS 90 X
SUSPENSION			
Type	Front	Independent suspension – A-arm. DS 90 X: Double A-arm	
	Rear	Rigid swing arm	
Travel	Front	86 mm (3.4 in) DS 90 X: 178 mm (7 in)	
	Rear	160 mm (6.3 in) DS 90 X: 178 mm (7 in)	
Shock absorber		Oil DS 90 X: HPG	
TIRES			
Pressure	Front	Minimum: 25 kPa (3.5 PSI) Maximum: 35 kPa (5 PSI)	
	Rear		
Size	Front	19 x 7-8 DS 90 X: 20 x 6-10	
	Rear	18 x 9.5-8 DS 90 X: 18 x 10.5-8	
WHEELS			
Size	Front	8 x 5.5 DS 90 X: 10 x 5.5	
	Rear	8 x 7 DS 90 X: 8 x 8.5	
Wheel nuts torque	Front and rear	40 N•m (30 lbf•ft)	
BRAKES			
Front		Mechanical, drum DS 90 X: hydraulic, disc	
Rear		Mechanical, drum DS 90 X: hydraulic, disc	
Parking device		LH brake lever with parking brake	
DIMENSION AND WEIGHT			
Dry weight		111 kg (245 lb)	
Overall length		152 cm (59.8 in)	
Overall width		91 cm (35.8 in) DS 90 X: 111 cm (43.7 in)	
Overall height		93.5 cm (36.8 in) DS 90 X: 97 cm (38.2 in)	
Wheelbase		100 cm (39.4 in) DS 90 X: 102.4 cm (40.3 in)	
Ground clearance		11.5 cm (4.5 in)	