

Date : **March 27 2008**

Subject : **Service Tools**

No

2008-12

Year	Model
2006-2007-2008	All

BRP is proud to introduce its latest Service Tools Bulletin. These special tools were designed to help you efficiently service BRP vehicles. Please always make sure to use special tools along with the appropriate Shop Manual(s) and respect all safety measures.

Mandatory Tools: These tools are absolutely needed to perform certain service procedures. They will be automatically shipped to dealerships. They do not need to be ordered separately.

Recommended Tools: These tools will facilitate the Technicians work. They will not be automatically shipped to dealerships. They need to be ordered separately.



Table of contents

Tools by System:

Engine	P	2
Fuel	P	7
Cooling	P	7
Electrical	P	8
Lubrication	P	10
Propulsion / Transmission	P	10
Steering	P	13
Suspension	P	14
Various	P	16

Index of tools by Part Number:	P	18
---	---	----

Engine

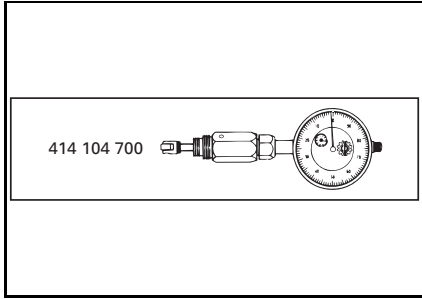

TDC dial indicator 25 mm
P/N 414 104 700 Recommended
 For ignition timing static measurement



Vacuum pressure pump
P/N 529 021 800 Recommended
 All models



Leak test kit (fuel/oil)
P/N 529 033 100 **Mandatory**
 All models



Spring installer remover
P/N 529 035 559 Recommended
 Replaced by 529035983 or 529035989

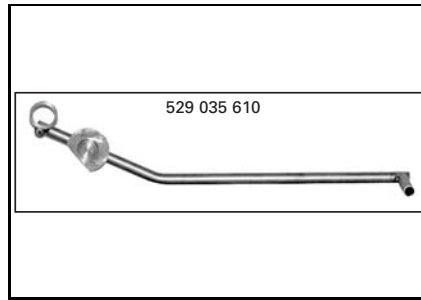

Engine lifting bar
P/N 529 035 610 Recommended
 Traxter 500

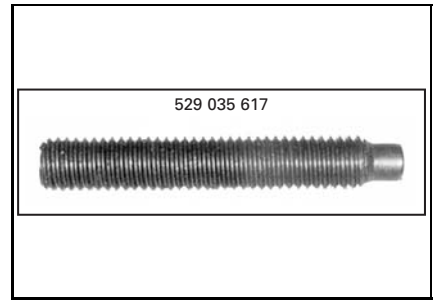

Crankshaft locking screw
P/N 529 035 617 **Mandatory**
 Quest 500/610,
 DS650/Outlander/Renegade

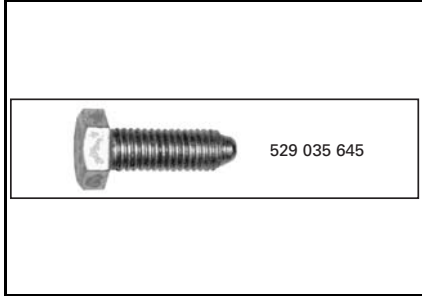

Crankshaft locking bolt
P/N 529 035 645 Recommended
 Traxter 500



Socket 46 mm
P/N 529 035 648 Recommended
 Traxter
 Crankshaft nut



Engine leak down test kit
P/N 529 035 661 Recommended
 All 4-stroke engines
 To perform a leak down test on engine.



Valve stem seal installer
P/N 529 035 687 Recommended
 610 engine



Valve spring compressor
P/N 529 035 724 Recommended
 4-TEC engines
 To be used with valve spring compressor
 cup 529 035 764 and 529 036 073

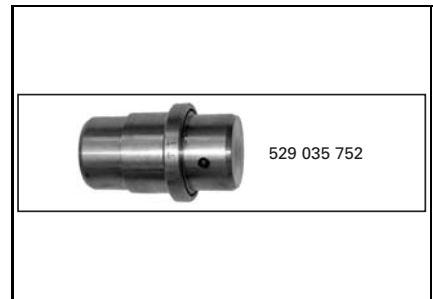

Crankshaft bearing puller
P/N 529 035 752 Recommended
 610/500 engines

Engine

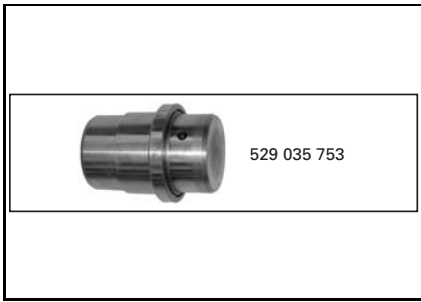

Crankshaft bearing puller
P/N 529 035 753 Recommended
 610/500 engines

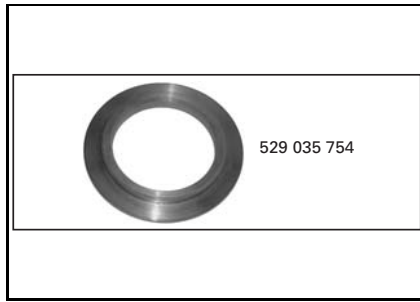

Crankcase support
P/N 529 035 754 Recommended
 Outlander 330/400, Quest 500/610



Valve spring compressor cup
P/N 529 035 764 Recommended
 V-1000/ V-1300/330/400/490/660/810
 To be used with valve spring compressor
 519 035 724.

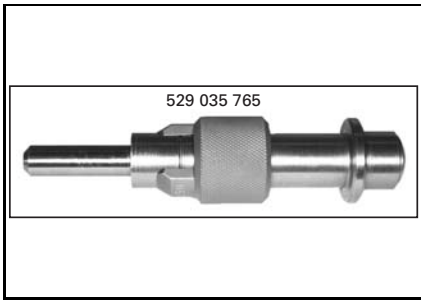

Piston circlip installer
P/N 529 035 765 **Mandatory**
 610/500/1503/V-1000 engines



Ceramic seal installer
P/N 529 035 766 Recommended
 All V-twin, 330/400, 610/500, 500 eng.
 Use with 529 036 130

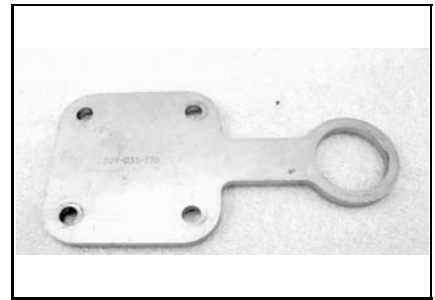

Engine lifting ring
P/N 529 035 770 Recommended
 Quest 610/500

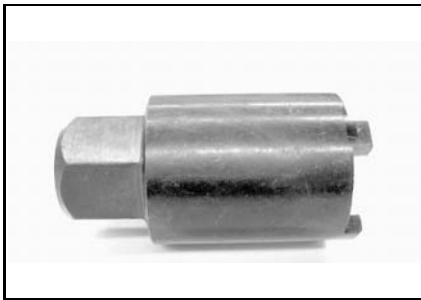

Oil pump rotor remover
P/N 529 035 795 Recommended
 DS 50, DS 90 2002/07



Suction pump
P/N 529 035 880 Recommended



Engine lifting bar
P/N 529 035 898 Recommended
 Outlander 330 & 400



Crankcase support (MAG side)
P/N 529 035 916 Recommended
 330/400 engine



Plain bearing remover/installer PTO/MAG
P/N 529 035 917 Recommended
 610, 500, 650, 800 engines



Piston ring compressor
P/N 529 035 919 Recommended
 V-800 engine

Engine

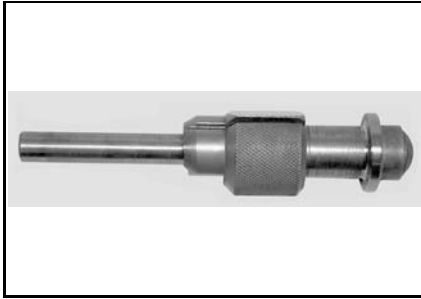

Piston circlip installer

P/N 529 035 921

Mandatory

330, 400, 500, 650, 800 engines



Valve guide remover 5 mm

P/N 529 035 924

Recommended

400, 500, 650, 800 engines

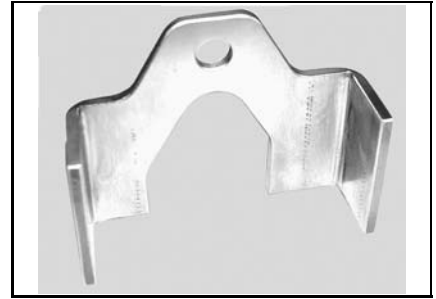

Camshaft locking tool

P/N 529 035 926

Mandatory

400, 500, 650, 800 engines



Oil seal installer

P/N 529 035 933

Recommended

449/991 engines, Outlander 330/400
Use with handle 420 877 650 Same usage
as 529 036 069.



Starter drive needle installer

P/N 529 035 934

Recommended

330/400 engine
Use with handle 420 877 650

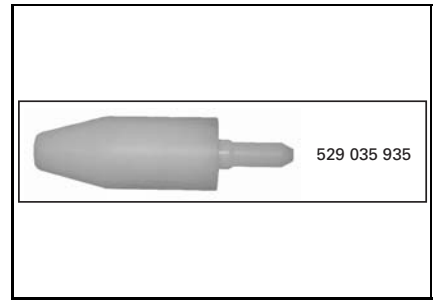

Oil seal protector

P/N 529 035 935

Mandatory

330/400 engine
Use on crankshaft MAG side



Piston ring compressor

P/N 529 035 977

Recommended

330 engine



Engine lifting tool

P/N 529 036 022

Recommended

V-490, V-660 & V-810 engines

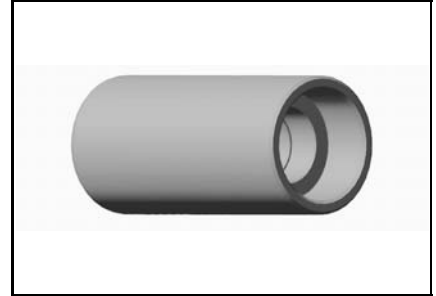

Drive shaft oil seal installer

P/N 529 036 028

Recommended

V-490, V-660 & V-810 engines

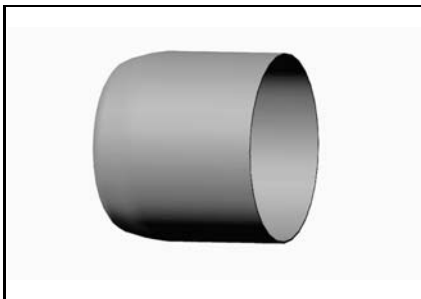

Drive shaft oil seal protector

P/N 529 036 029

Recommended

V-490, V-660 & V-810 engines



Crankcase support MAG/PTO

P/N 529 036 031

Recommended

V-490, V-660 & V-810 engines



PTO cover plain bearing remover

P/N 529 036 032

Recommended

V-490, V-660 & V-810 engines

Engine



PTO cover oil seal installer
P/N 529 036 033 Recommended
 V-490, V-660 & V-810 engines



Crankshaft protector
P/N 529 036 034 Recommended
 V-490, V-660 & V-810 engines

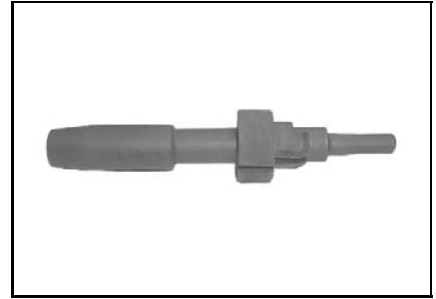

Piston circlip installer
P/N 529 036 048 Recommended
 DS 250

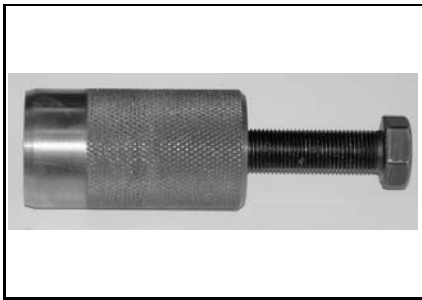

Magneto puller
P/N 529 036 049 **Mandatory**
 DS 250



Crankshaft protector
P/N 529 036 051 Recommended
 DS 250



Camshaft locking tool
P/N 529 036 055 **Mandatory**
 DS 250

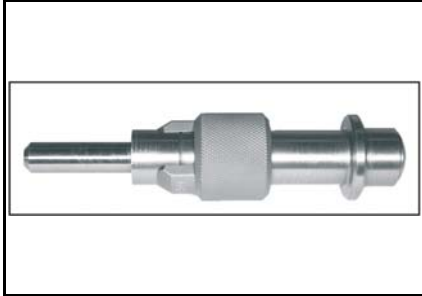

Piston circlip installer
P/N 529 036 058 Recommended
 V-490 engine

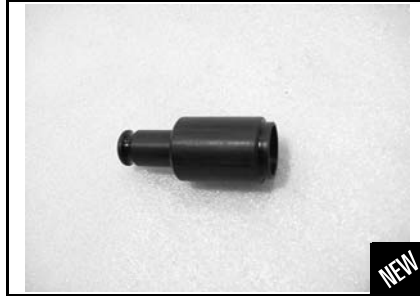

Oil seal installer
P/N 529 036 069 Recommended
 449/991 engines, Outlander 330/400
 Use with handle 420 877 650
 Same usage as 529 035 933.



Valve spring compressor cup
P/N 529 036 073 Recommended
 449, 991, 610/500 engines, Traxter 500
 To be used with 529 035 724

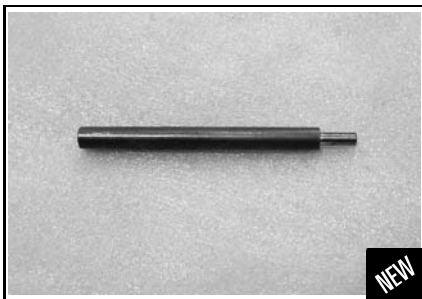

Valve guide remover (6 mm)
P/N 529 036 074 Recommended
 449, 991 engines
 valve guide pusher

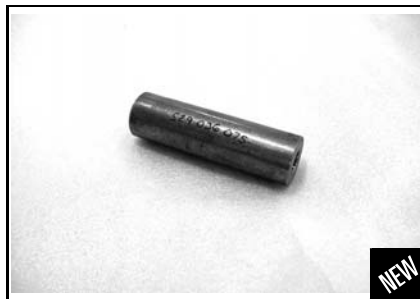

Valve guide installer (6 mm)
P/N 529 036 075 Recommended
 449, 991 engines
 Valve guide insertion jig



Wrench 11 mm
P/N 529 036 076 **Mandatory**
 449 engine
 Clutch

Engine



Bearing installer
P/N 529 036 078 Recommended
 449 engine
 Use with handle 420 877 650

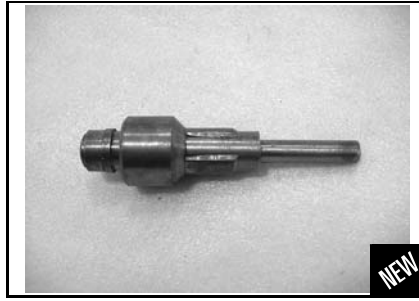

Piston circlip installer
P/N 529 036 083 **Mandatory**
 449 engine



Camshaft adjustment tool
P/N 529 036 084 Recommended
 449 engine

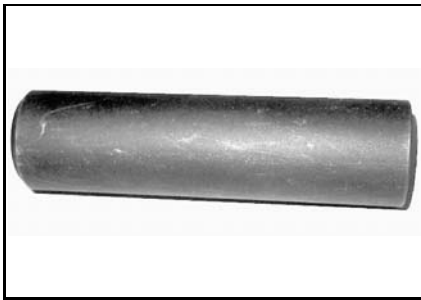

Valve Guide Installer 6 mm
P/N 529 036 087 Recommended
 1503, Traxter 500, Quest 610/500



Crank lock, driven open tool
P/N 529 036 098 **Mandatory**
 610/500, 991, V-490, V-660, V-810



Crankshaft locking screw
P/N 529 036 107 **Mandatory**
 449 engine



Ceramic seal pusher plate
P/N 529 036 130 Recommended
 V-490, V-660 & V-810 engines
 Use with ceramic seal installer 529035766



Piston ring compressor
P/N Snap-on RC 980 Recommended
 4-TEC
 Not sold by BRP

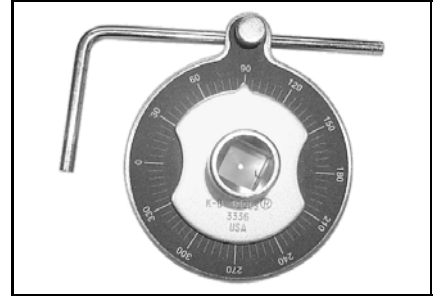

Torque angle gauge
P/N Snap-on TA362 Recommended
 Used on most 4-stroke engines.
 Not sold by BRP

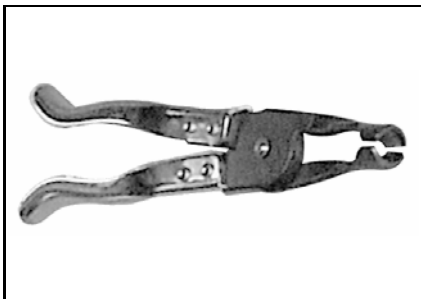

Valve stem seal removal pliers
P/N Snap-on YA 8230 Recommended
 1503, 991 engines, DS650
 Not sold by BRP

Fuel

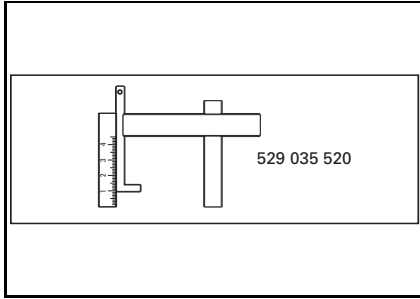

Float lever measurement
P/N 529 035 520 Recommended
 Carburetor-equipped vehicles



Fuel pressure gauge
P/N 529 035 591 Recommended
 787 RFI, 793 SDI & 4-TEC engines
 Replaced by 529 035 709. Spare plastic clip P/N 275500429



Oil/fuel pressure gauge
P/N 529 035 709 **Mandatory**
 Injection type engines
 Use with 529035652, 529035714 & 529036023

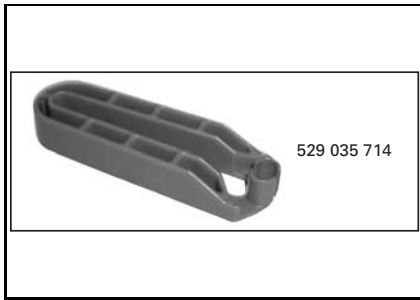

Fuel line remover
P/N 529 035 714 **Mandatory**
 Injection models
 Used also with gauge P/N 529 035 709, 529 035 652 & 529 036 023

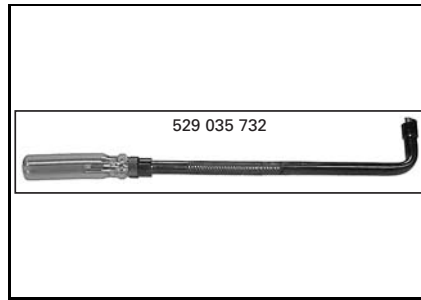

Adjustment tool pilot screw
P/N 529 035 732 Recommended

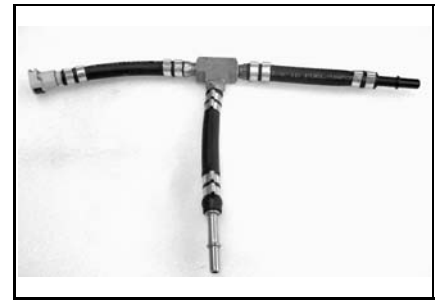

Fuel hose adapter
P/N 529 036 023 **Mandatory**
 Injection type vehicles
 To be used with 529 035 709. Replacement clip 513 033 135

Cooling



Test cap
P/N 529 035 991 Recommended
 All models
 To be used with Vacuum/Pressure Pump 529 021 800.



Coolant pump oil seal installer
P/N 529 036 052 Recommended
 DS 250



Water pump seal installer
P/N 529 036 139 Recommended
 449 engine

Electrical

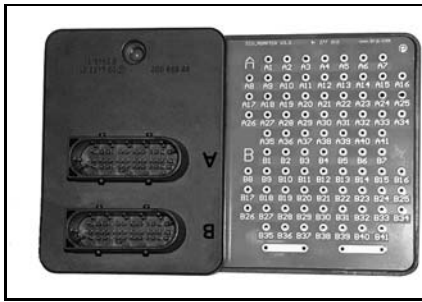

ECM adapter tool
P/N 420 277 010 **Mandatory**
 All models
 All injected 2-TEC & 4-TEC with VDO ECM

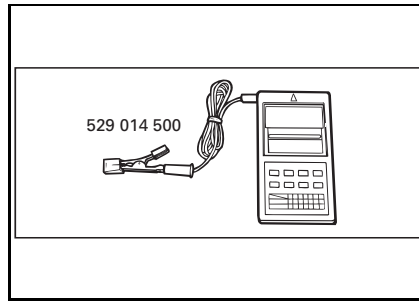

529 014 500
 Digital induction tachometer
P/N 529 014 500 Recommended
 All models

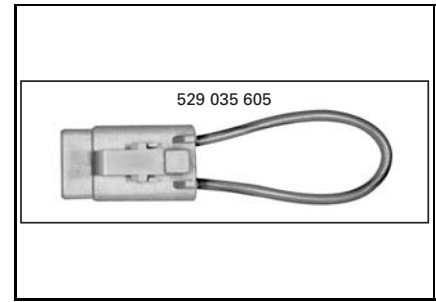

529 035 605
 Wire jumper
P/N 529 035 605 Recommended
 Traxter

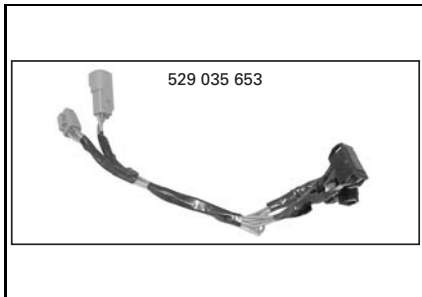

529 035 653
 T harness
P/N 529 035 653 Recommended
 Traxter
 To check shifting.



529 035 730
 Crimping plier for heavy gauge wire
P/N 529 035 730 Recommended
 All models
 Ex.: To crimp battery cable terminals.



529 035 748
 Flywheel puller
P/N 529 035 748 **Mandatory**
 All V-twin



Digital multimeter (basic model)
P/N 529 035 774 Recommended

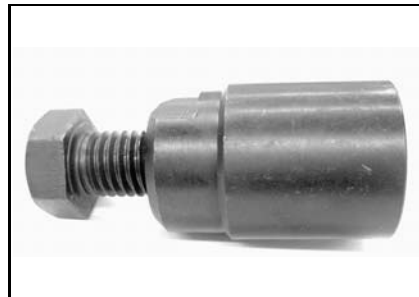

Flywheel puller
P/N 529 035 792 Recommended
 DS 50/90, MY 2002-7



Magneto puller
P/N 529 035 798 Recommended
 DS 50, DS 90 2002/07



529 035 868
 Fluke 115 digital multimeter
P/N 529 035 868 Recommended
 All models



AMP die
P/N 529 035 908 Recommended
 All models with AMP connectors
 To use with crimping tool 529 035 909 to crimp Deutsch connectors.



Crimping tool
P/N 529 035 909 Recommended
 To use with compatible die to crimp different connectors

Electrical

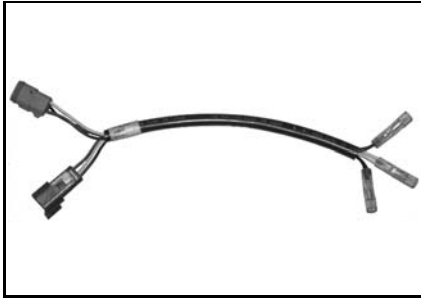

Magneto harness adapter

P/N 529 036 016 Recommended
1503, 449
To test the magneto.

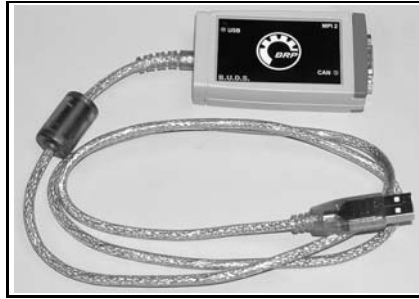

MPI-2 interface card

P/N 529 036 018
Replaces the MPI.

Mandatory

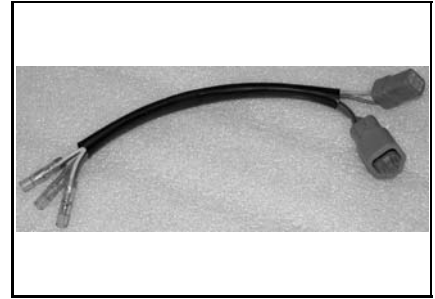

4-pin magneto diagnostic harness

P/N 529 036 021 Recommended
V-490, V-660 & V-810 engines

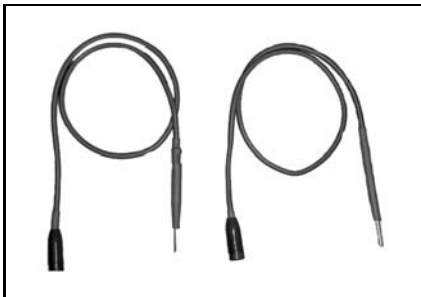

Test probes

P/N 529 036 063 Recommended
All models
To back probe various connectors.



ECM adapter tool

P/N 529 036 085
449, 400 EFI engines

Mandatory

NEW



MPI-2 diagnostic cable

P/N 710 000 851 **Mandatory**
All DESS-equipped vehicles

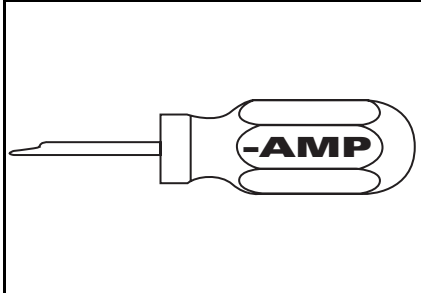

Multilock terminal housing connector ext

P/N AMP 755430-2 Recommended
Not sold by BRP

Lubrication

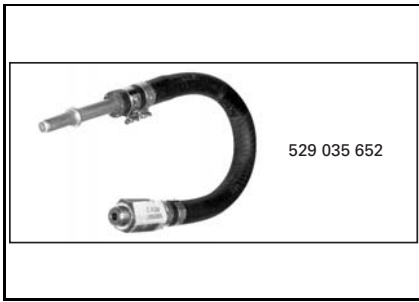

Hose oil pressure

P/N 529 035 652

Mandatory

4-TEC engines

Used with 529 035 709.

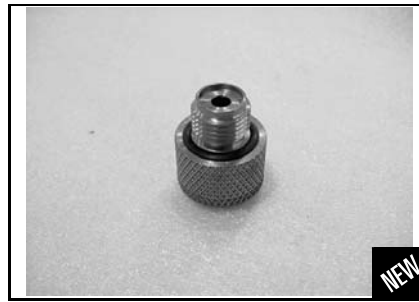

Oil pressure adapter

P/N 529 036 079

Mandatory

449 engine

To be used with 529 035 652.

Propulsion / Transmission



Drive pulley holder (CVT)

P/N 529 006 400

Recommended

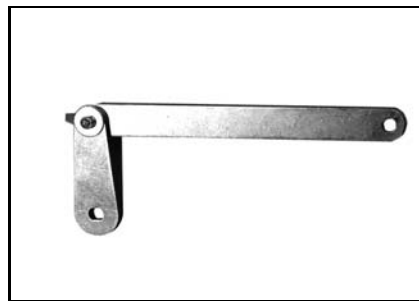

Transmission wrench

P/N 529 035 599

Recommended

Traxter

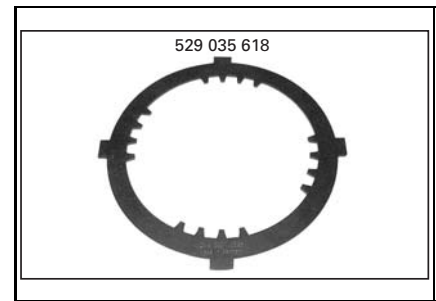

Clutch assembly holder

P/N 529 035 618

Recommended

Traxter

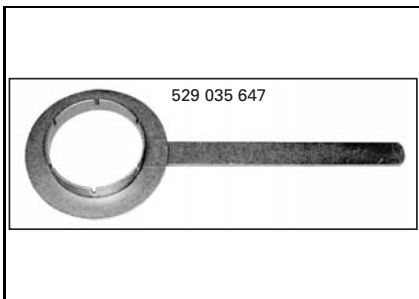

Clutch spanner

P/N 529 035 647

Mandatory

Traxter, 449 engine

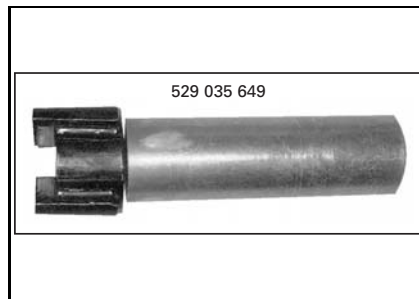

Socket spanner

P/N 529 035 649

Recommended

Outlander, Traxter & Quest
To remove the pinion screw in the differential.



Backlash measurement tool

P/N 529 035 665

Recommended

Outlander, Renegade

Propulsion / Transmission



Oil seal installer
P/N 529 035 693 Recommended
 449 engine

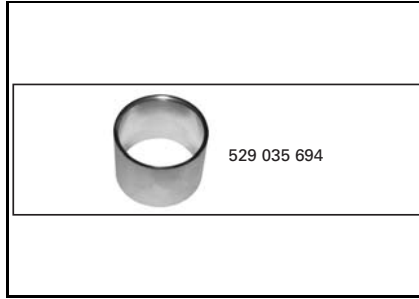

Install ring wear
P/N 529 035 694 Recommended
 DS 650
 Rear axle

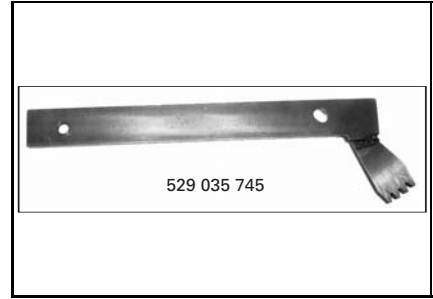

Clutch holder
P/N 529 035 745 Recommended
 610/500 engines



Clutch puller
P/N 529 035 746 **Mandatory**
 610/500, V-490, V-660, V-810 engines

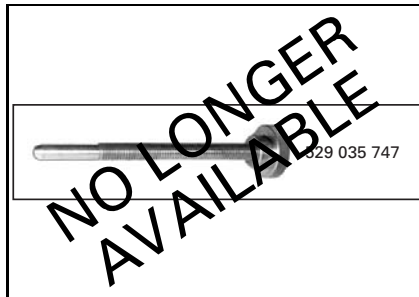

Gear lock pin
P/N 529 035 747 Recommended
 610/500, V-490, V-660, V-810 engines
 Replaced by 529036098



Oil seal installer (gearbox)
P/N 529 035 758 Recommended
 V-490, V-660, V-810 engines
 Use with handle 420 877 650



Bearing installer (gearbox)
P/N 529 035 762 Recommended
 V-490, V-660, V-810 engines
 Use with handle 420 877 650



Bearing installer (gearbox)
P/N 529 035 763 Recommended
 V-490, V-660, V-810 engines
 Use with handle 420 877 650

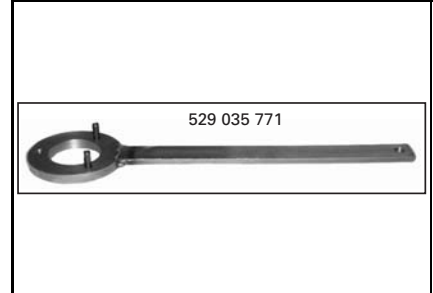

Driven clutch holder
P/N 529 035 771 Recommended
 330/400, 610/500, V-490, V-660, V-810



Bearing alignment tool
P/N 529 035 806 Recommended
 Quest 500 & 650



Oil seal installer
P/N 529 035 854 Recommended
 449 engine



Needle bearing installer (output shaft)
P/N 529 035 858 Recommended
 DS 70, DS 90
 Use with handle 420 877 650

Propulsion / Transmission

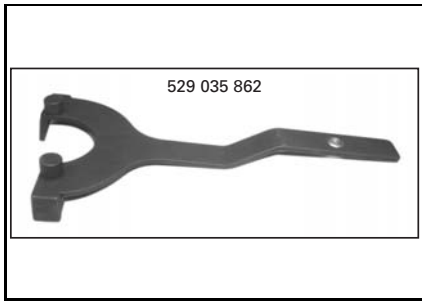

Clutch holding tool
P/N 529 035 862 Recommended
 Rally 200



Clutch support
P/N 529 035 863 Recommended
 Rally 200

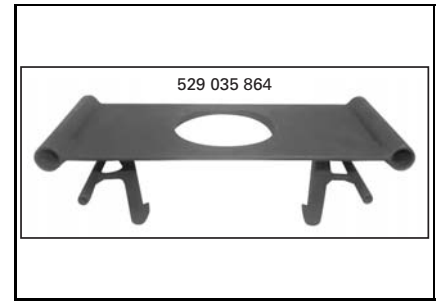

Clutch holding tool
P/N 529 035 864 Recommended
 Rally 200 & DS 250

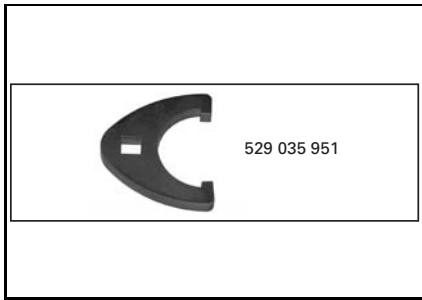

Rear axle key
P/N 529 035 951 Recommended
 DS 650

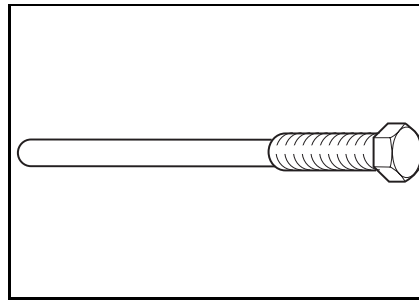

Clutch puller
P/N 529 035 992 Recommended
 Sarasota



CV joint extractor
P/N 529 036 005 Recommended
 Outlander/Renegade V-660 & V-810

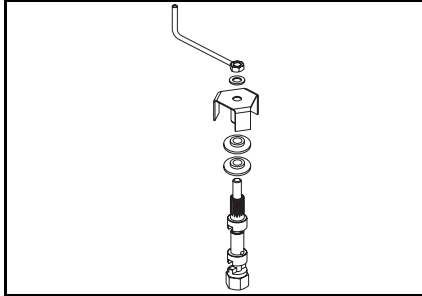

Clutch/driven spring compressor tool
P/N 529 036 012 Recommended
 Most drive & driven pulleys



Backlash measurement tool
P/N 529 036 030 Recommended
 Outlander/Renegade

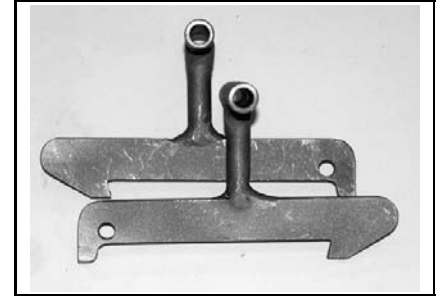

Driven pulley support tabs
P/N 529 036 047 Recommended
 DS 250

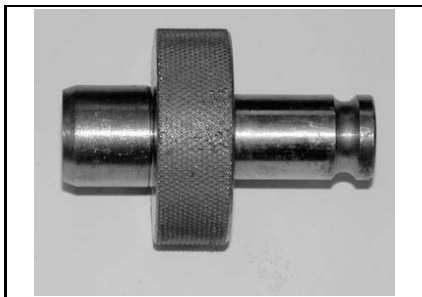

Countershaft bearing installer
P/N 529 036 053 Recommended
 DS 250
 Use with handle 420 877 650

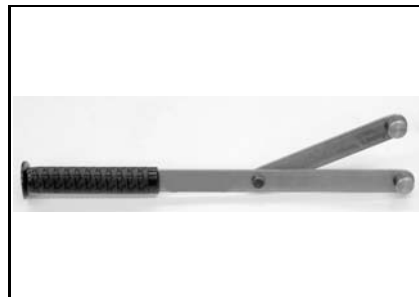

Pulley Holder
P/N 529 036 054 Recommended
 Rally, DS 250, DS 70/90



Protection sleeve
P/N 529 036 068 Recommended
 449 engine

Propulsion / Transmission

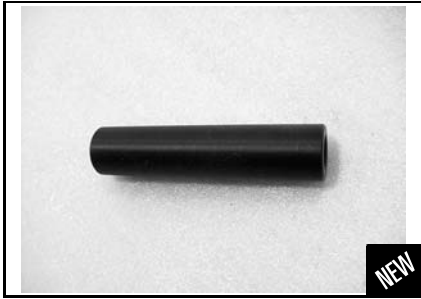

Oil seal installer
P/N 529 036 070 Recommended
449 engine
insertion jig for gearshift shaft

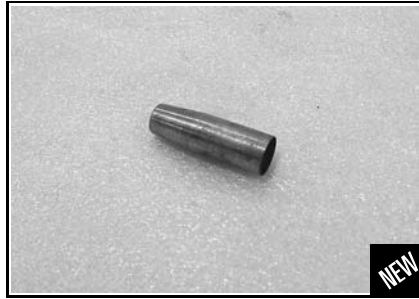

Protection sleeve
P/N 529 036 071 Recommended
449 engine
Gearshift shaft



Axle key
P/N 529 036 082 Recommended
DS 450



Oetiker clamp pincer (CV joint)
P/N 529 036 120 Recommended
All models
For Stepless Low Profile Clamps 192
Clamp pincer with special jaw form

Steering



Heated grip installer
P/N 529 035 897 Recommended
Straight grips

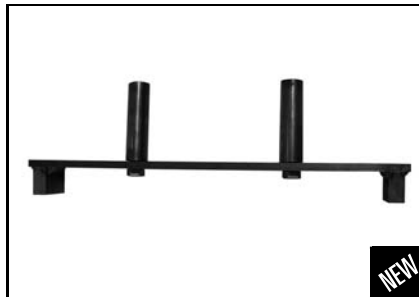

Direction alignment tool
P/N 529 036 059 Recommended
All except DS 450

Suspension

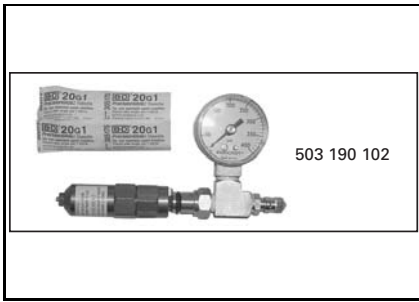

Gas shock filling tool
P/N 503 190 102 Recommended
 T/A shocks
 To be used with P/N 529035570. Spare
 needle P/N 529035930.



Ball joint installer
P/N 529 000 012 Recommended
 REV, RT, DS 650, DS 450

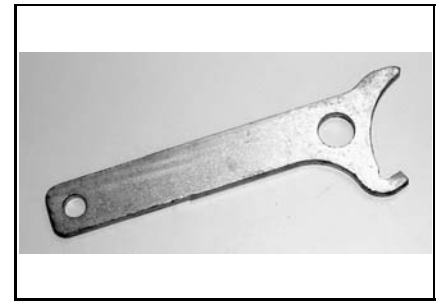

Shock preload adjustment wrench
P/N 529 032 900 Recommended

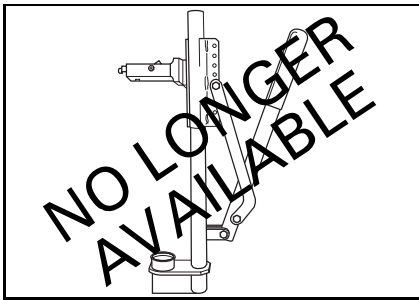

Spring compressor
P/N 529 035 504 Recommended
 No longer sold, replaced by P/N 529 036
 007.

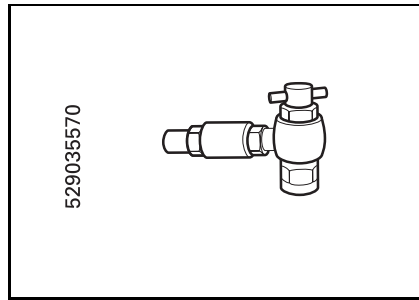

Shock filling valve
P/N 529 035 570 Recommended
 T/A shocks

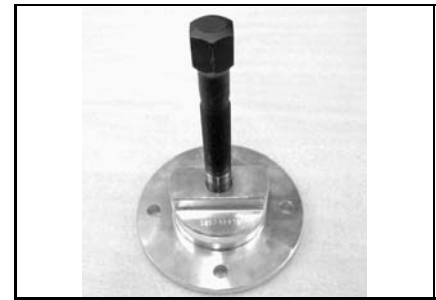

Hub puller
P/N 529 035 612 Recommended

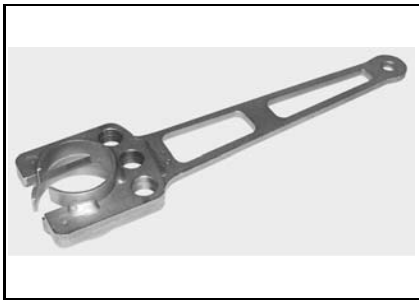

Shock wrench
P/N 529 035 727 Recommended
 All T/A shocks

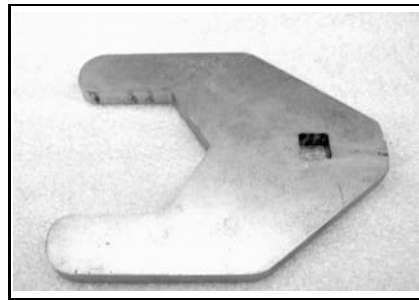

Wrench
P/N 529 035 729 Recommended
 DS 650



Open wrench 50 mm
P/N 529 035 866 Recommended
 Rally
 Rally axle nut



Ball joint remover support
P/N 529 035 873 Recommended
 REV, RT
 Replaced by 529036121



Ball joint installer support
P/N 529 035 875 Recommended
 REV, RT, Outlander



Crow foot
P/N 529 035 884 Recommended
 Rally 200
 Rear axle nut

Suspension

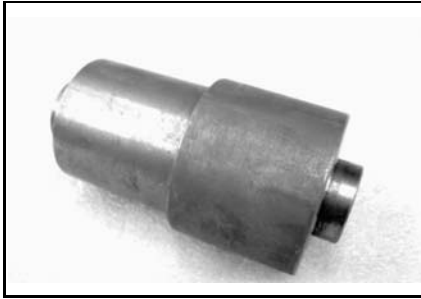

Bearing remover/installer

P/N 529 035 918

Mandatory

Outlander, Renegade, DS 450

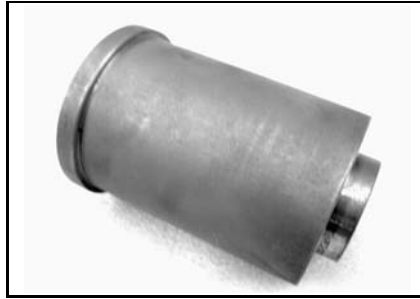

Trailing arm bearing install./remover

P/N 529 035 920

Mandatory

Outlander, Renegade



Bearing remover trailing arm support

P/N 529 035 922

Mandatory

Outlander, Renegade



Swing arm retaining nut socket

P/N 529 035 925

Mandatory

Outlander, Renegade



Spring Remover

P/N 529 036 007

Recommended

All models
To remove coil spring from shock.

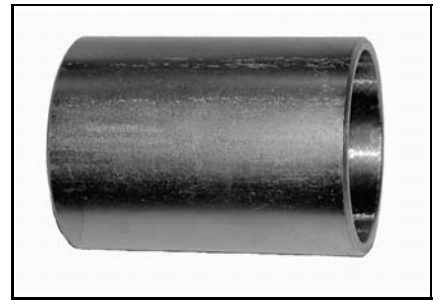

Ball joint installer

P/N 529 036 020

Mandatory

Outlander/Renegade



Rear axle key

P/N 529 036 046

Recommended

DS 250

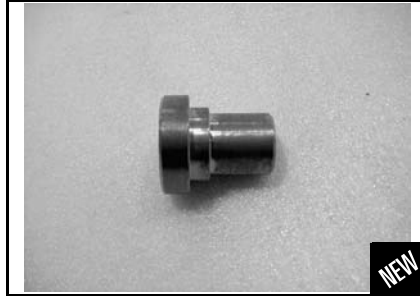

Needle bearing installer

P/N 529 036 109

Recommended

DS 450



Ball joint remover support

P/N 529 036 121

Recommended

REV, RT, Outlander, roadsters

Various

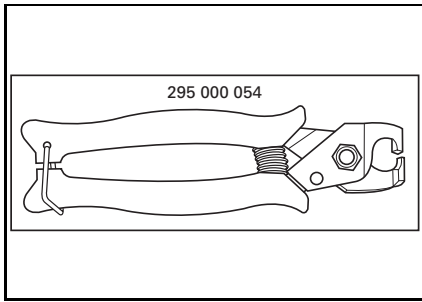

Caillau pliers

P/N 295 000 054

Recommended

All models

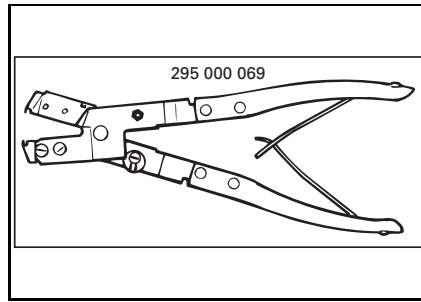

Oetiker Pliers

P/N 295 000 069

Recommended

All models

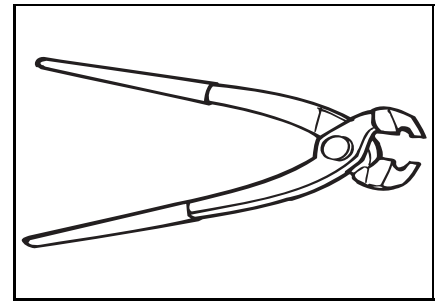

Oetiker pliers

P/N 295 000 070

Recommended

All models

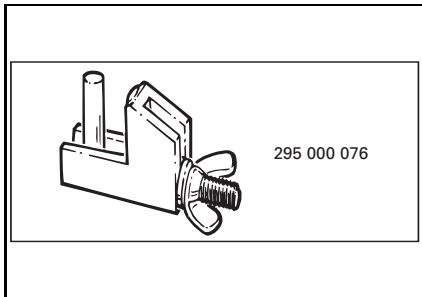

Small hose pincher

P/N 295 000 076

Recommended

All models

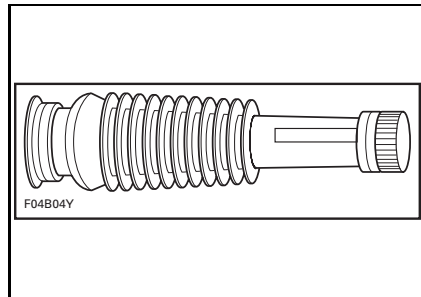

Flexible spout for oil

P/N 414 837 300

Recommended

All models

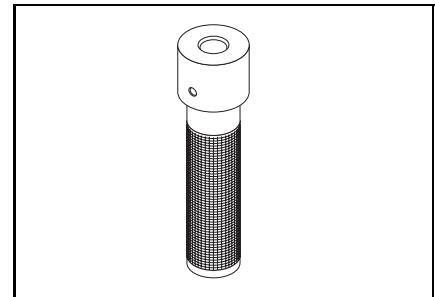

Pusher handle

P/N 420 877 650

Recommended

All models

To be used with many pushers.



Supertitanium drill bit 3/16"

P/N 529 031 800

Recommended

To drill/remove many kinds of rivet.

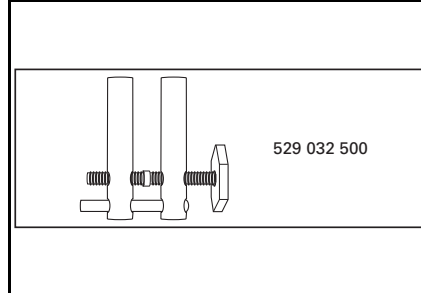

Large hose pincher

P/N 529 032 500

Recommended

All models

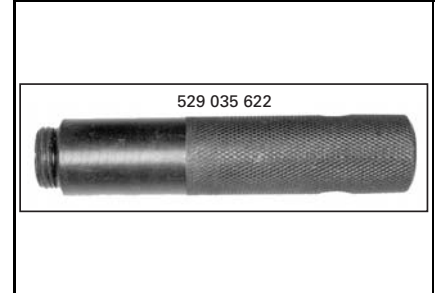

Cover remover

P/N 529 035 622

Recommended

DS 650



Cable luber

P/N 529 035 738

Mandatory

All cables



Allen key 3 mm

P/N 529 035 781

Recommended

DS 50, DS 90 2002/07



Output shaft seal installer

P/N 529 035 941

Mandatory

400 engines

Use with handle 420 877 650

Various

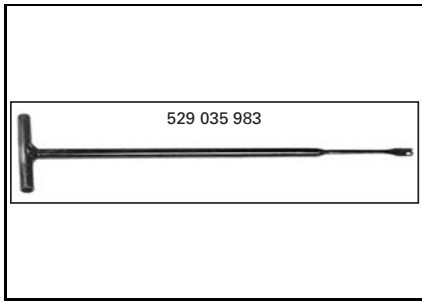

Spring removal tool

P/N 529 035 983

Recommended

All models



Blind hole bearing puller set

P/N 529 036 117

Recommended

All models

Replaced by 529036056

Index

Tool Part Numbers ... Page

These tools are mandatory

295000054 16	529035747 11	529035983 17	529036120 13
295000069 16	529035748 8	529035991 7	529036121 15
295000070 16	529035752 2	529035992 12	529036130 6
295000076 16	529035753 3	529036005 12	529036139 7
414104700 2	529035754 3	529036007 15	710000851 9
414837300 16	529035758 11	529036012 12	AMP 755430-2 9
420277010 8	529035762 11	529036016 9	Snap-on RC 980 6
420877650 16	529035763 11	529036018 9	Snap-on TA362 6
503190102 14	529035764 3	529036020 15	Snap-on YA 8230 6
529000012 14	529035765 3	529036021 9	
529006400 10	529035766 3	529036022 4	
529014500 8	529035770 3	529036023 7	
529021800 2	529035771 11	529036028 4	
529031800 16	529035774 8	529036029 4	
529032500 16	529035781 16	529036030 12	
529032900 14	529035792 8	529036031 4	
529033100 2	529035795 3	529036032 4	
529035504 14	529035798 8	529036033 5	
529035520 7	529035806 11	529036034 5	
529035559 2	529035854 11	529036046 15	
529035570 14	529035858 11	529036047 12	
529035591 7	529035862 12	529036048 5	
529035599 10	529035863 12	529036049 5	
529035605 8	529035864 12	529036051 5	
529035610 2	529035866 14	529036052 7	
529035612 14	529035868 8	529036053 12	
529035617 2	529035873 14	529036054 12	
529035618 10	529035875 14	529036055 5	
529035622 16	529035880 3	529036058 5	
529035645 2	529035884 14	529036059 13	
529035647 10	529035897 13	529036063 9	
529035648 2	529035898 3	529036068 12	
529035649 10	529035908 8	529036069 5	
529035652 10	529035909 8	529036070 13	
529035653 8	529035916 3	529036071 13	
529035661 2	529035917 3	529036073 5	
529035665 10	529035918 15	529036074 5	
529035687 2	529035919 3	529036075 5	
529035693 11	529035920 15	529036076 5	
529035694 11	529035921 4	529036078 6	
529035709 7	529035922 15	529036079 10	
529035714 7	529035924 4	529036082 13	
529035724 2	529035925 15	529036083 6	
529035727 14	529035926 4	529036084 6	
529035729 14	529035933 4	529036085 9	
529035730 8	529035934 4	529036087 6	
529035732 7	529035935 4	529036098 6	
529035738 16	529035941 16	529036107 6	
529035745 11	529035951 12	529036109 15	
529035746 11	529035977 4	529036117 17	